

# KONAN®

Download PDF catalog data  
from the following website

**URL=<https://www.konan-em.com/>**

For pneumatic

## MAGSTAR IIF Series 3 • 5 Port SOLENOID VALVES Air Operated Valves

# MAGSTAR IIF

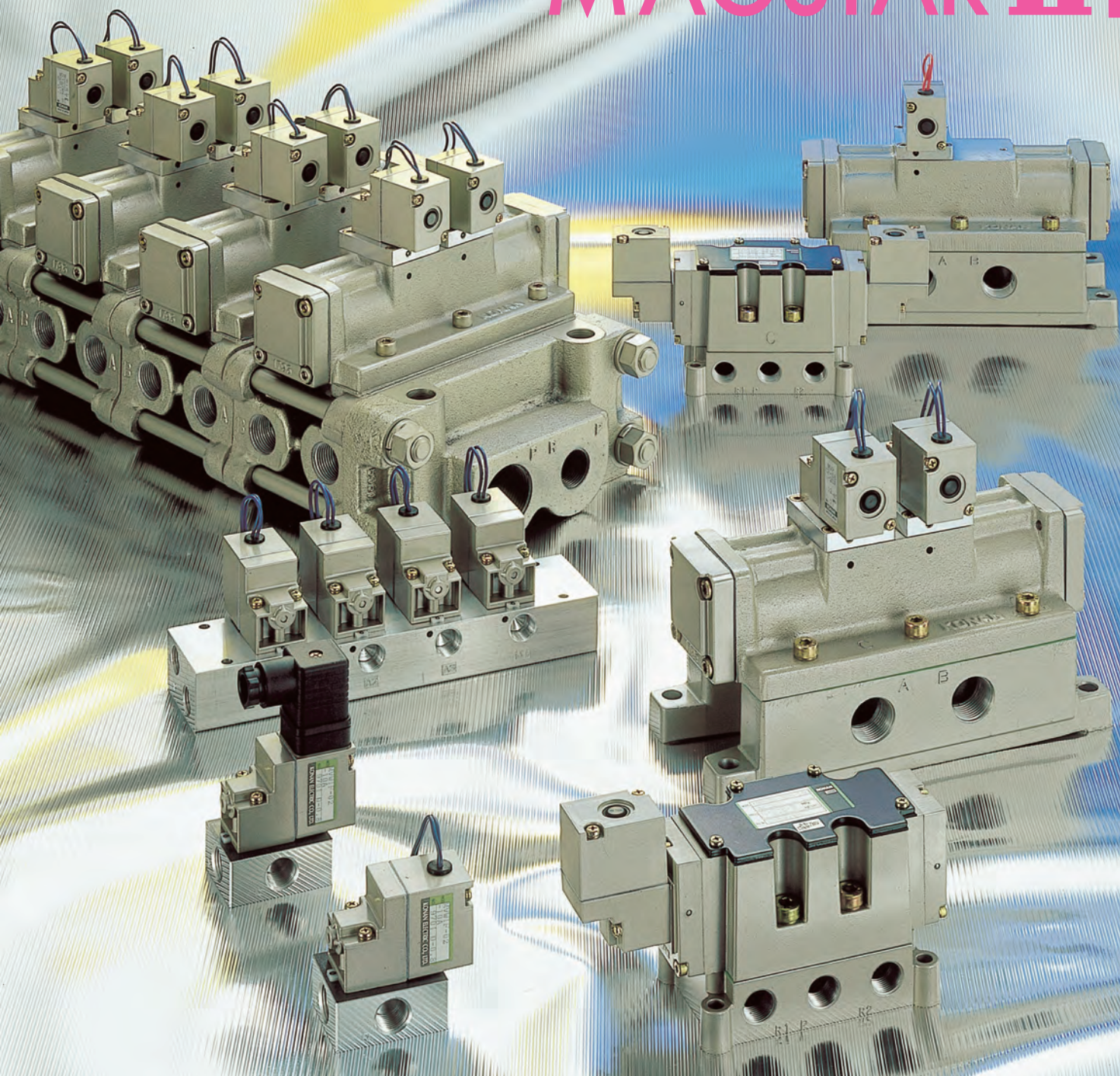

The MAGSTAR is a registered trademark  
of Konan Electric Co., Ltd.  
**KONAN ELECTRIC CO.,LTD.**



## Easy to handle

The wiring terminals are made wide to facilitate the wiring work. (Type 03 and 08)

## Improved durability

The spool packing of the main valve was changed to I-ring. Durability and reliability during oilless use have been further improved.(Type 03)

# MAGSTAR

## II F

### MAGSTER II F Series

### 3 • 5 Port SOLENOID VALVES

The Magstar II solenoid valve was further powered up. It is a high-performance valve that pursues further ease of use while maintaining its excellent basic design and numerous features.

## Various options

In addition to conventional DIN connectors, a variety of options are available, including waterproof conduit connectors.(Type 02)

# INDEX

# MAGSTAR

	PAGE
General Handling Precautions	4
<b>INFORMATION</b>	<b>8</b>
<b>SOLENOID VALVES</b>	<b>11</b>
<b>3 PORT SOLENOID VALVES</b> Gasket-connected type	11
MVW1F-02	
MVW1RF-02	
<b>5 PORT SOLENOID VALVES</b> Gasket-connected type	<b>13</b>
MVS2F-03 · 08	
MVD2F-03 · 08	
MVPCF-03 · 08	
MVPOF-03 · 08	
MVPEF-03 · 08	
<b>Manifold solenoid valves</b>	<b>20</b>
<b>3 PORT SOLENOID VALVES</b> Manifold type	22
MVM3F-02-SE1	
MVM3F-02-SP1	
<b>5 PORT SOLENOID VALVES</b> Manifold type	<b>24</b>
MVM5F-03 · SP1	
MVM5F-08 · SP1	
MVM5F-03 · SP2	
MVM5F-08 · SP2	
<b>Air Operated Valves</b>	<b>26</b>
<b>5 PORT Air Operated Valves</b> Gasket-connected type	26
AVS2F-03, AVS2-08	
AVD2F-03, AVD2-08	
AVPCF-03, AVPC1-08	
AVPOF-03, AVPO1-08	
AVPEF-03, AVPE1-08	
<b>Determination of Flow-Rate</b>	<b>30</b>

# Solenoid Valves for Fluid Control and Valve Systems

## General Handling Instructions and Precautions

Please read the following general handling precautions carefully before ordering solenoid valves for fluid control.

Following information is based on a risk assessment for Konan general purpose solenoid valves used for fluid systems (hereafter referred to as Agvalve(s)Ah). Each section provides information essential for safe operation of valve systems and prevention of risk and damage that may affect operators. Please read carefully.

## Safety Precautions

### References:

JIS B9702:  
Safety of machinery principles of risk assessment  
JIS B8370:  
Pneumatic fluid power general rules relating to systems

 **Warning** A valve is operated by switching electric signals to increase / decrease or stop/supply fluid. It is widely used for fluid control systems in general. For safe operation of the valve, care should be taken especially for the following points.

### ① Selection of solenoid valves

#### 1.1 Applicable fluid

A valve should be used with compressed air only, except for cases where nitrogen gas tank<sup>1)</sup> is used for system inspection, emergency measure, or portable pressure source. If highly dry air with dew point of no more than -40°C is to be used, make sure to use the valve with lubrication taking into consideration the dryness measure.

For a general purpose solenoid valve (for liquid and gas fluid) for which air is not specified as one of applicable fluids, do not employ compressed air as a flow media. For anything unclear regarding applicable fluids, feel free to ask our sales personnel in the planning stage.

Note1) Be careful to avoid suffocation of operators and others around the valve system. For a system that uses portable air or nitrogen tank, the High Pressure Gas Safety Law will be applied where fluid pressure exceeds 1 MPa.

#### 1.2 Safety of a valve

A pneumatic system may be exposed to various hazardous environment, including those derived from the system components as well as the condition for use and the system structure. In selecting a valve make sure to take into consideration the valve function as well as safety in installation, adjustment, actual operation, system failure, and disposal of the valve.

#### 1.3 Electrical safety

A solenoid valve is activated by magnetic force (solenoid). Take into consideration the following matters when selecting a valve and electric options.

- 1) Dust-proof/water-proof specification Water-proof indication should follow JIS C0920.
- 2) Sudden shut down of power source (power failure, emergency shutdown, etc.)
- 3) Voltage fluctuation in power source and electrical surge
- 4) Leakage current at PLC (sequencer) power off Konan solenoid valves are not equipped with functions that meet the following conditions. Do not use the valves in these conditions or employ a safe electric distribution.
  - 1) External magnetic field effect
  - 2) Electric current from the relevant control circuit
  - 3) Lightning-induced voltage

#### 1.4 Pilot valve

A compact size pilot valve is widely used in general, as it switches large main valve with a small output. However, a certain inlet pressure is essential for the valve operation. For control of minimal pressure, select a direct-acting type valve. With optional pilot supply (separate pilot piping needed), a pilot valve can be used even when the main valve pressure is zero.

#### 1.5 Back pressure from exhaust port

In some poppet valves, back pressure from the exhaust port may affect the valve operation. There is no problem with the back pressure generated in the silencer set at the exhaust port, but do not force to narrow the exhaust port diameter or connect a long pipe to the port. Details of the effect of back pressure are described in a separate operation manual. For anything unclear feel free to contact our sales personnel.

#### 1.6 Reverse flow

Use a valve complying with the flow direction indicated with arrow mark in the JIS figure of the catalogue and operation manual. Safe operation cannot be guaranteed if the valve is used with reverse pressure or reverse flow. There is no problem with the slow reverse flow exhaustion during maintenance or compressor power off. If valve operation is stopped abnormally, a failure may occur when restarting operation due to the stop position of the valve. If reverse flow is detected at abnormal stop or any trouble at the restart of the valve is concerned, feel free to ask our sales personnel.

#### 1.7 Manual operation

- 1) If there is a possibility that manual operation button of a valve may be pushed unexpectedly, select a valve equipped with protection cover.
- 2) If failure to unlock manual operation of a valve may cause serious danger, select a valve without locking function.

### ② Solenoid valve installation

Solenoid valves have precise operational functions and are used for applications with versatile conditions and environment. It is therefore sometimes difficult to assume all concerned risks or risk factors when designing a valve. In such cases the valve function and performance may be deteriorated in a period shorter than the maintenance period set by the manufacturer. In order to avoid the risks, install the valve as instructed below.

#### 2.1 Installation site

Install a valve in a place where setting and maintenance is easy. As a valve is often incorporated into an existing main system, consideration for maintenance is sometimes insufficient. Secure enough space for safety of the valve operation.

#### 2.2 Operating procedure

When operating a valve to activate a pneumatic cylinder and other actuators, install the components and complete piping, and then start operation of the actuators with small load and slow speed, gradually adjusting them to rated conditions while confirming no abnormalities or air leakage in the valve and actuators.

#### 2.3 Bursting out of a cylinder

After installation or maintenance, supply air after confirming that a cylinder is in a targeted valve control position. If not in

the position, the cylinder may rapidly shift to the control position. In order to avoid this risk, installation of a slow-start valve at the IN port of the valve is recommended.

Note) (See Section 2.4) When installing a slow-start valve at the IN port of a pilot valve, adjust a bypass valve of the slow-start valve in order to maintain minimal operational pressure of the pilot valve. If the bypass valve diameter is excessively narrowed, the pilot pressure will become less than the minimal operational pressure, which may cause valve malfunction.

Also, when restarting air supply, open a manual valve in a short period of time while checking manometer to secure minimal operational pressure of the pilot valve, and then supply air slowly.

## 2.4 Securing pilot pressure

Install a pilot valve taking care for the following matters.

- 1) Inlet pressure of a valve should be higher than the minimal operational pressure. Especially if air supply is not enough, pressure fluctuation may occur during the valve operation and pressure may be below the lower limit of the operational pressure.
- 2) If long piping is employed at the inlet of a valve or the pipe diameter is smaller than the port diameter, pressure drop may occur, resulting in the inlet pressure decrease.

Note: One countermeasure is to install a supplementary air tank in front of the inlet port. In order to confirm no decrease in inlet pressure, install a manometer around the port.

- 3) For a manifold type solenoid valve, make sure to connect allowable number of valves only. Simultaneous operation with excess number of valves (more than 3 units in standard) may cause centralized pressure drop at the manifold, decreasing the valve inlet pressure.

Note: For a manifold with two inlet ports, the number of valves can be increased by supplying air from both ports.

## 2.5 Indication

If a valve nameplate cannot be seen due to installation environment, place an alternative indication near the valve.

## 2.6 Residual pressure

Compressed air in a pneumatic valve system may not be completely exhausted after the valve power shut down. Residual pressure may cause unintended cylinder operation in the system. A valve should be installed taking into consideration the risks including sudden blowout of residual air.

## 2.7 Air exhaustion

At an exhaust port of a valve, sonic jet flow may occur, causing noise as well as damage to operator due to the fragments and dusts spread by the jet flow. If any personnel may come closer to the exhaust port, install a silencer to avoid noise and adjust air flow.

## 2.8 Training

A sufficiently trained person should be responsible for installation and maintenance of a pneumatic system. (Konan provides training for operation and maintenance of pneumatic components. Feel free to contact our sales personnel for details.)

## ③ Maintenance of solenoid valves

Maintenance should be performed in accordance with the following steps. Feel free to contact our sales personnel for separate maintenance manual.

### 3.1 Daily inspection

- 1) Drains contained in compressed air may inhibit the valve lubrication. Set an air filter in front of the valve and routinely exhaust drains.actuators.

- 2) During the valve system operation, check the valve visually and acoustically for external abnormalities or noise. Check also the loosening of screws and air leakage from exhaust port and piping joint without exhausting air from the system, and perform periodical inspection as necessary to recover any abnormalities.

### 3.2 Periodical inspection

Following periodical inspection should be conducted by-annually or annually.

- 1) Overhaul should be performed after pneumatic/electric shut-down and abnormalities recorded and repair conducted as necessary.
- 2) In the 2nd periodical inspection, perform an overhaul of the product, repair or exchange solenoid assAfy, coil, packings, and other components as necessary. However, even before 2 years has passed, the valve that reached the specified durable operation cycle<sup>2)</sup> should be over hauled and parts exchanged if necessary.

Note2) [Laboratory durable operation cycle]: New Magstar 414 series and heavy duty series solenoid valves: 5 million cycles

Durable operation cycle for each valve is specified in the operation manual or drawing. This cycle is determined based on the Konan standard test results. Inspection interval should be determined referring to the actual installation environment or storage records.

- 3) If a valve is not used for a long time, the valve function may be deteriorated when restarting operation, due to precipitation or effusion of lubricant film. According to the JIS standard, minimal operation frequency of a valve is specified as once in 30 days. Before reaching that date perform periodical test operation or take other measures for preventing the valve deterioration.

### 3.3 Residual energy

Maintenance requiring actual operation of a system should be performed after pneumatic/electric shut-down and exhaustion of all residual electrical charge and compressed air from the system. Make sure the movable components do not move during the maintenance, and mechanically fix them if necessary for safety. Care should also be taken for components that may drop out during the maintenance operation and components with sharp edges to ensure safety.

### 3.4 Communication

If multiple persons are involved in the maintenance operation, keep all the personnel informed about the conditions including power-off, completion of residual pressure exhaustion, power-on, and resumption of air supply.

## ④ Solenoid valve installation site

Use of a valve at the following sites requires compliances with special functional specifications and regulations. Consult our sales personnel in the planning process for anything unclear. thing unclear.

- 1) Operating conditions not within the specified range
- 2) Significant risk for users, properties, or environment is anticipated

Eg: Use in explosive environment<sup>3)</sup>, use for nuclear power plants, vehicles, medical components, components related to the Occupational Health and Safety Law and/or the High Pressure Gas Safety Law, etc.

Note3) : Select Konan explosion-proof solenoid valves for use in general gas explosive environment.

## Users Instructions

Followings are comprehensive precautions for operation of a solenoid valve and a system incorporating a valve. Make sure to keep in mind these matters for maintaining safety.

### **Caution** ① **Transport of solenoid valves**

#### 1.1 Weight

For safety of operators, heavy-weight valves and valve units should be transported with the aid of conveyer equipment. Valve weight can be confirmed by referring to Konan Pneumatic Solenoid Valve Catalogue and product drawings. Mini-size valves should be handled with care, as they may collapse by excessive force. Especially make sure not to hold the lead wire when transporting the valves.

#### 1.2 Dropping

During lifting or horizontal transportation of a valve, handle the valve carefully not to drop or damage.

#### 1.3 Dust prevention

Plastic plug is attached to the valve connection ports to prevent dusts and rusts from entering the valve. Do not remove the plug until immediately before piping. If the plug is lost, take a protection measure with alternative cover.

### **Caution** ② **Storage**

#### 2.1 Storage during transport

If a valve is to be installed where it is exposed to wind and rain or other adverse environment, transport the valve to the specified site just before installation. If the valve is to be stored at the installation site by necessity, keep it packed and protect with a sheet cover.

#### 2.2 Storage

A valve should be stored as follows to prevent contamination and material deterioration.

- 1) Avoid high temperature and humidity as well as places with dusts.
- 2) If a valve is to be stored for more than 1 year, keep it packed or provide equivalent protection.
- 3) Long-term storage may result in sticking of packings or other components due to shortage of lubrication. In such cases, conduct pre-conditioning operation of the valve before regular use.
- 4) After a long period of storage, permanent deformation, change of size, or deterioration of packings and other components would be a concern. After such storage period, conduct a valve operation test. If any abnormalities are found, perform an overhaul or exchange deformed/deteriorated components as appropriate

### **Warning** ③ **Surrounding environment**

#### 3.1 Vibration/shock

- 1) Install a valve using hose connection to avoid the place where the valve is exposed to excessive shock or vibration. Care should be taken not to make outlet piping longer, which may affect system response.
- 2) If a valve is to be installed in a place where it is exposed to excessive shock or vibration, set the valve with a vibration isolation table. Ensure the valve is firmly fixed at the setting and connection portions fastened tightly. After start of operation, inspect the connections in a periodical manner to check any loose parts or deformation and re-fasten screws.

#### 3.2 Handling during installation

For safety of operators

Do not ride on a valve and pipes or hang wires on the operational equipment during installation.

#### 3.3 Surrounding environment

Environment surrounding a valve should be considered carefully. Avoid places where the valve is exposed to rain and wind, direct sunlight, salt, corrosive gas, chemical fluids, organic solvents, steam, etc. Corrosion resistance measure can be taken depending on the environment. Feel free to contact our sales personnel for details.

#### 3.4 Working temperature

Use a valve with specified range of ambient temperature and fluid temperature. Care should be taken especially for the following cases.

- 1) Temperature of compressed air around an air compressor may become high, which may cause deterioration of packings or malfunction of the valve.
- 2) Coil life depends on thermal degradation of insulation material. Avoid high temperature environment or continuous energization as much as possible.
- 3) In a place where temperature is close to 0°C, remove moisture in the compressed air with an air dryer. If the dehumidification is not performed, significant amount of moisture may freeze inside the valve to cause malfunction.

### **Warning** ④ **Modification**

Do not modify a solenoid valve. Unexpected risk may arise.

### **Caution** ⑤ **Intermediate stop of a cylinder by control of a solenoid valve**

- 1) A pneumatic cylinder can be stopped intermediately by controlling with a 3-position closed-center type solenoid valve. Due to compressible nature of air, however, precise stop position or retention rigidity of the stop position cannot be secured.
- 2) If the piping area between the speed control valve and the closed-center solenoid valve is large, air shifts from inside the cylinder to the valve pipings even after the valve is closed, thus the stop position shifts. In order to avoid this, install a speed control valve in front of the closed-center valve to minimize piping length.
- 3) As sealing portions inside a valve or cylinder system allow minimal leakage, it is difficult to maintain the intermediate stop position for a long time. If long-term retention of the stop position is necessary, install mechanical retention equipment such as brake, lock, or latching system.

### **Caution** ⑥ **Spray lubrication using a lubricator**

See Konan Solenoid Valve Catalogue if a valve needs lubrication. For valves that need lubrication, set a lubricator at the inlet of the valve and perform spray lubrication.

#### 6.1 Type of lubricating oil

- 1) Use JIS K 2213 (ISO VG32 or VG46) type turbine oil for lubrication using a lubricator.
- 2) Spray volume of a lubricator is determined by the number of oil drops (typically 0.03cm<sup>3</sup> per drop or 1.5 to 2.5 drops per 1m<sup>3</sup> of air).

#### 6.2 Centralized lubrication

In principle 1 lubricator should be used for 1 valve. Lubricating multiple valves may result in uneven oil supply to each valve or actuator, particularly if there are differences in the operation



frequency, pipe length, size, and installation height of the actuators. By grouping the valves and actuators with similar conditions, centralized lubrication can be achieved.

### 6.3 Selection of oilless solenoid valve

For control of an oilless actuator, select an oilless solenoid valve. If the valve is not frequently used, lubricated oil may not reach the valve or actuator due to little spray volume.

- 1) Use specified grease for overhaul of an oilless solenoid valve. Reconfirm the type of grease with our sales personnel.
- 2) A greased oilless valve or oilless actuator can be lubricated, but once lubricated, the grease will be exhausted. Although durability is enhanced after the lubrication, continual lubrication will be required.



## Reference ⑦ Pneumatic system control

### 7.1 Sequence control

Follow the below steps for sequence control of an actuator incorporating a pneumatic valve.

- 1) Detect the position.
- 2) Interlock the circuit of the valve that controls other actuators in the system.

### 7.2 Power failure and pneumatic pressure failure

- 1) In case of power failure or emergency stop during a sequence operation, select normal stop position of the valve so that the cylinder at operation stops or shifts to a safe position. Depending on the type of valve following action may be seen at emergency stop.
  - a) Single-acting return type: Shifts to the start position.
  - b) Double-acting detent (retention) type: Shifts to the final stop position.
  - c) Closed-center type: Stops at the current position.
- 2) If operation is stopped in the middle of sequence and restarting operation from the stopped position may cause any trouble, manually control each actuator to return to the start position. Indicate procedure to recover operation.
- 3) If operation is stopped in the middle of sequence and air inside the system exhausted, a cylinder piston may drop due to gravity or it may rapidly shift at the next air supply to damage operator or surrounding equipment. Make sure to return the piston to the start position before exhausting air from the system.
- 4) In order to complete a cycle operation even in case of pressure failure, reserve sufficient amount of pneumatic pressure in an air tank.



## Warning ⑧ Residual pressure exhaustion

In a system circuit using a check valve (non-return valve), a pilot check valve, and/or a closed center solenoid valve, exhaust residual pressure separately or indicate warnings for residual pressure, as air may be contained even the system is not in operation.

Indicate the manual type valve for residual pressure exhaustion in the system circuit drawing.



## Reference ⑨ Circuit and piping

### 9.1 Pressure drop

In a pneumatic control system employing long pipes at the end or entrance of the system, sufficient pressure may not be supplied due to pressure drop. Piping thus should be designed properly, or supplementary air tank should be installed to secure supply pressure if a valve is operated intermittently.

### 9.2 Air filtration

Air supplied to a valve should be filtrated by a filter with nominal filtration rating of no more than 40 mm to remove solid contaminants. Exhaust liquid drain or oil through the filter or drain separator after sufficient cooling of the air.

Exposure to contaminated, high temperature compressed air may deteriorate packings or other components, making the valve life shorter.

### 9.3 Piping

- 1) Use galvanized pipe for steel tube piping and remove dusts after screwing.
- 2) Before connection, clean the pipes by air flushing or washing to remove internal dusts, moisture, and oil.
- 3) If a seal tape is used for screwing, wrap the tape around twice or three times in a direction opposite to the screwing direction, leaving 1.5 to 2 threads from the screw edge.
- 4) When screwing pipes and joints into a valve, use an appropriate size of wrench and fasten the pipes and joints to the extent not causing air leakage. Forceful screwing may result in cracking of the valve connection port or leakage/malfunction due to contamination with fragments of sealing materials.
- 5) In case of 6A to 25A (Rc1/8 to 1) size pipes or joints, 4 to 5 threads should be screwed. An exercise for seal tape wrapping and screwing before actual work is recommended.
- 6) A valve (especially large-size valve) should be fixed not only with the piping but also with supporting components. For some mini-size solenoid valves with steel tube piping, supporting components may be used for the piping portion. In this case sufficiently support around the valve with piping clamp and other components.



## Caution ⑩ Electrical circuit and piping

- 1) Reconfirm that the voltage and current (AC or DC) of power source and the valve to be used are identical.
- 2) For DC solenoid, check the polarity of the connection terminal to avoid improper connection.
- 3) For a double solenoid valve with common terminal, make sure not to perform improper common connection.
- 4) If TRIAC is used for the AC output of the PLC (sequencer), leakage current at power shut down may affect action of solenoid or indicator lamp. In such case submit the PLC output specification to the PLC manufacturer or Konan sales personnel to discuss about a method to decrease leakage current.
- 5) Power surge due to electromagnetic induction at solenoid power off may significantly shorten the operating life of junction on the electrical circuit. For Konan solenoid valves without surge absorber, consult our sales personnel for a method to connect surge absorber.
- 6) For lead wire connection, wiring should be conducted using appropriate connecting terminal while keeping the wire loose.



## Caution ⑪ Special valves

For valves with special specifications like below, consult our sales personnel before ordering regarding the conditions for use.

- 1) Use with carbon gas or nitrogen gas
- 2) Use under conditions with high/low temperature or high radiant heat
- 3) Use at a place with ozone or salt
- 4) Use in explosive environment



## Warning ⑫ Disposal

- 1) Do not incinerate a valve for disposal. It may explode or emit poisonous gas.
- 2) Check the material of each component of a valve with catalogue or operation manual for segregation disposal. Konan solenoid valves do not include materials indisposable as general industrial waste.

# INFORMATION

## 1 Type

Magstar IIF solenoid valve series is classified as follows:

### 1-1. 3-port solenoid valve

3-port solenoid valve has 3 ports: fluid inlet (P-port), outlet (A-port), and exhaust port (R-port). This is mainly used for operation of single-acting actuators or diaphragm valves. The valve structure is as follows:

Normally closed : Air flow stops when solenoid is de-energized.

Normally open : Air flows when solenoid is de-energized.

### 1-2 5-port solenoid valve

5-port solenoid valve has 5 ports: a fluid inlet (P-port), 2 load connection ports (A- and B-ports), and 2 exhaust ports (R1- and R2-ports).

This valve is mainly used for operation of double-acting actuators. Two types (return, hold) are available, and three positioning (closed center, exhaust center, pressure center) can be selected. The exhaust port can be used as connection to flow control valve (exhaust valve).

### 1-3 Air-operated valve

This valve controls direction of air flow using air pressure signals, unlike solenoid valves that utilize solenoid. The valve performance is comparable to that of solenoid valves, except slightly longer response time.

## 2 JIS symbols

Solenoid valves are expressed by JIS-specified graphic symbols and characters based on JIS B0125 "Fluid power systems and components." Each symbol is shown in the Model code section.

## 3 Model code

DC solenoid valves have no polarity.

## 4 Specifications

All specifications described in the catalogue are based on the results of varied tests performed in accordance with JIS B8374-1993 "Pneumatic system – 3-port solenoid operated valves" and JIS B8375-1993 "Pneumatic system – 5-port solenoid operated valves" The other parameters below are common to all solenoid valves.

Internal leakage	Less than the value specified in JIS B8374/8375
Ambient relative humidity	Not more than 95%
Insulation resistance	Not less than 10 M $\Omega$ (Measured by 500 V Megger test)
Withstand voltage	Commercial frequency, 1500 V, 1 min

**Consult with us if the product is to be used with specifications other than those listed above.**

## 5 Manual operation mechanism

The manual operation mechanism (push button) is provided as standard on all models of Magstar IIF solenoid valve series. Pressing the push button (black) on the pilot valve activates the valve as if it were energized.

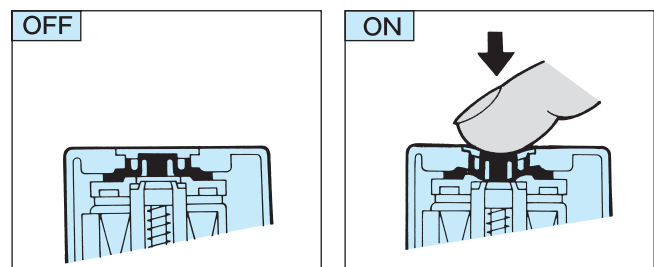



## 6 Wiring and connection

Select the most suitable wiring method for the solenoid valve from the following seven types.

Lead wire type	DT : DIN connector type (w/o Lamp)	DN : DIN connector type (with Lamp)				
<div data-bbox="188 338 509 517" data-label="Diagram"> <p>Electrical connection diagram</p> </div> <p data-bbox="188 528 509 613">The attached lead wire is about 300 mm from the coil part.</p> <div data-bbox="188 745 509 1008" data-label="Diagram"> <p>Lead wire (ℓ = 300mm)</p> </div> <p data-bbox="188 1019 509 1104">The attached lead wire is about 300 mm from the body part.</p> <div data-bbox="188 1243 509 1523" data-label="Diagram"> <p data-bbox="236 1395 300 1417">ℓ = 200mm</p> </div> <p data-bbox="188 1536 509 1621">Be careful in wiring, not to give undue tension to the lead wires.</p>	<div data-bbox="657 338 978 517" data-label="Diagram"> <p>Electrical connection diagram</p> </div> <div data-bbox="657 555 1437 600" data-label="Section-Header"> <h3>Compatible cable size</h3> </div> <p data-bbox="657 607 1225 636">Use a cable with a finished size of <math>\phi</math> 8 to <math>\phi</math> 10.</p> <div data-bbox="657 667 1437 712" data-label="Section-Header"> <h3>Each part name of DIN connector</h3> </div> <div data-bbox="657 734 1437 1088" data-label="Diagram"> </div> <div data-bbox="657 1122 1437 1167" data-label="Section-Header"> <h3>Wiring order</h3> </div> <ol data-bbox="657 1173 1437 1545" style="list-style-type: none"> <li>Loosen the cover set screws, remove the cover, and pull out the terminal block.</li> <li>Pass the cable through the gland nut, washer, packing, and cover, remove the lead wire coating, and twist both ends.</li> <li>Loosen the terminal fixing screws ① and ② on the terminal block, fully insert each lead wire, and tighten the screws. In addition, crimped terminals can also be used for connection.             <ul data-bbox="699 1373 1437 1487" style="list-style-type: none"> <li>● Applicable crimped terminals : Equivalent to JIS C 2805 R1 .25-3 (Terminal groove width : 6.5 mm / Tightening small radius: M3)</li> <li>● If it is desirable to use the DIN connector for conduit wiring (wire drawing port G1/2), request us separately.</li> </ul> </li> <li>After selecting the cable extraction direction (side where the cover is attached), tighten the cover fixing screw.</li> </ol> <div data-bbox="657 1570 1437 1615" data-label="Section-Header"> <h3>The change the cable take-out direction</h3> </div> <p data-bbox="657 1630 1150 1749">For the DIN connector and conduit connector, the wire exit can be changed in 4 directions by loosening the cover set screw and pulling out the cover.</p> <div data-bbox="1161 1637 1437 1861" data-label="Diagram"> </div>	<div data-bbox="1114 338 1437 517" data-label="Diagram"> <table border="1"> <thead> <tr> <th data-bbox="1114 338 1273 383">Electrical connection diagram (AC)</th> <th data-bbox="1273 338 1437 383">Electrical connection diagram (DC)</th> </tr> </thead> <tbody> <tr> <td data-bbox="1114 383 1273 517"> </td> <td data-bbox="1273 383 1437 517"> </td> </tr> </tbody> </table> </div>	Electrical connection diagram (AC)	Electrical connection diagram (DC)		
Electrical connection diagram (AC)	Electrical connection diagram (DC)					

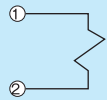
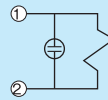
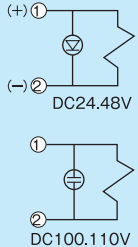
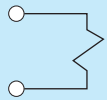
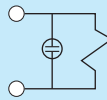
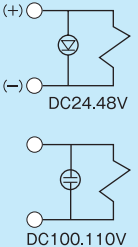
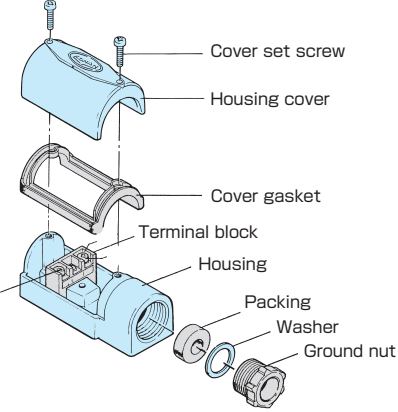
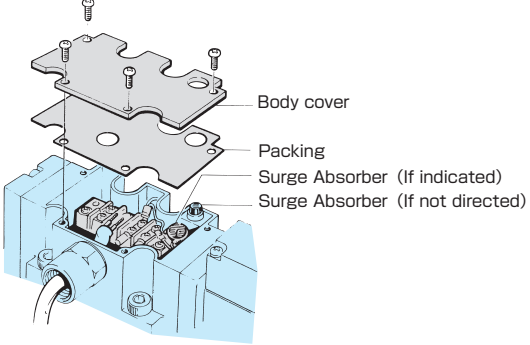
TBF1 : Conduit connector (w/o indicator)	TBF1N : Conduit connector (w/o indicator)	T : Terminal w/o indicator	N : Terminal w/ indicator
<p>Electrical connection diagram</p> 	<p>Electrical connection diagram (AC)</p>  <p>Electrical connection diagram (DC)</p> 	<p>Electrical connection diagram</p> 	<p>Electrical connection diagram (AC)</p>  <p>Electrical connection diagram (DC)</p> 
<p><b>Compatible cable size</b></p>		<p><b>Compatible cable size</b></p>	
<p>Use a cable with a finished size of <math>\phi</math> 6.5 to <math>\phi</math> 13.5.</p>		<p>Use a cable with a finished size of <math>\phi</math> 6 to <math>\phi</math> 8.</p>	
<p><b>Each part name of conduit connector</b></p>		<p><b>Wiring order (with terminal)</b></p>	
			
<p><b>Wiring order</b></p>		<p><b>Wiring order</b></p>	
<ol style="list-style-type: none"> <li>① Remove the cover retaining screws (2) and then, remove the housing cover.</li> <li>② Pass the cable through the wire outlet of the housing cover, remove the lead wire insulation, and twist both ends.</li> <li>③ Loosen the terminal fixing screws ① and ② on the terminal block, fully insert each lead wire, and tighten the screws. In addition, crimped terminals can also be used for connection. <ul style="list-style-type: none"> <li>● Applicable crimped terminals : Equivalent to JIS C 2805 R1 .25-3 (Terminal groove width : 6.5 mm / Tightening small radius: M3)</li> </ul> </li> <li>④ Tighten the housing cover with set screws.</li> </ol>		<ol style="list-style-type: none"> <li>① Remove the cover retaining screws (4) and then, remove the body cover.</li> <li>② Pass the cable through the wire outlet of the main body, remove the lead wire insulation, and twist both ends.</li> <li>③ Loosen the terminal fixing screws on the terminal block, fully insert each lead wire, and tighten the screws. In addition, crimped terminals can also be used for connection. <ul style="list-style-type: none"> <li>● Applicable crimped terminals : Equivalent to JIS C 2805 R1 .25-3 (Terminal groove width : 6.5 mm / Tightening small radius: M3)</li> </ul> </li> <li>④ Tighten the body cover with set screws.</li> </ol>	

## 7 Compatibility with Magstar II (conventional products)

If you are using a conventional Magstar II solenoid valve and want to replace it with a Magstar II solenoid valve, be sure to note the following points. Since the height and direction of the push button are different, make sure there is enough space around the valve to mount it. When replacing only the main body of the O3 type solenoid valve, the body mounting bolts will be changed from M6 to M8.

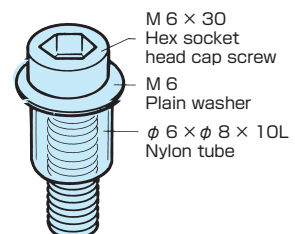

# 3 MAGSTER II F

## Port SOLENOID VALVES

Gasket-connected type

MVW1F-02	Normally Closed	Rc 1/8 · 1/4 · 3/8
MVW1RF-02	Normally Open	

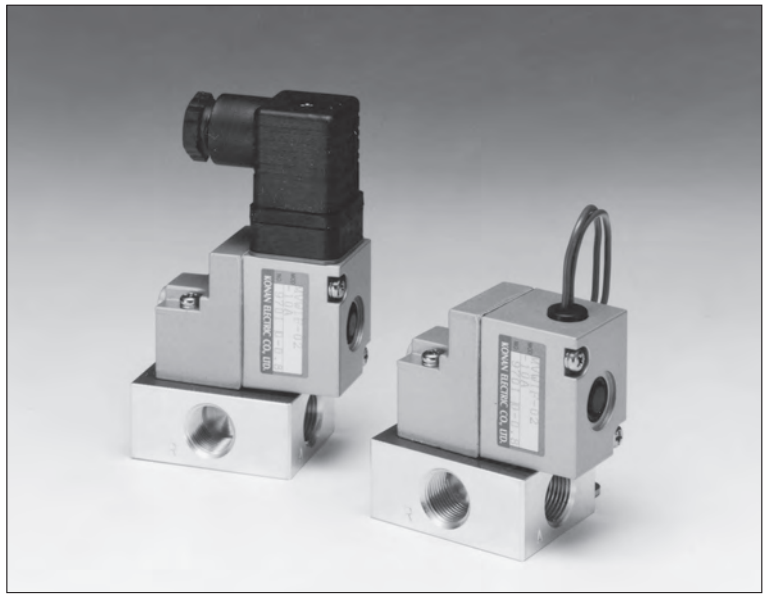

**Model Code** When ordering, specify the model as follows.

**MVW1** 1 **F-02-** 2 - 3 - 4

**1 Type of valve flow path**

Normally Closed		No entry
Normally Open		R

**2 Port size**

Rc 1/8	6A
Rc 1/4	8A
Rc 3/8	10A

**3 Type of wiring**

Lead wire		No entry
DIN connector	w/o lamp	DT
	with lamp	DN
DIN connector with surge absorber	w/o lamp	DTZ
	with lamp	DNZ
Conduit connector	w/o lamp	TBF1
	with lamp	TBF1N
Conduit connector with surge absorber	w/o lamp	TBF1Z
	with lamp	TBF1NZ

**4 Port size**

AC100V 50/60Hz	AC100
AC110V 50/60Hz	AC110
AC200V 50/60Hz	AC200
AC220V 50/60Hz	AC220
AC125V 50/60Hz	AC125
DC24V	DC24
DC48V	DC48
DC100V	DC100
DC110V	DC110

● The conduit connector has a waterproof class (JIS C 0920), drip-proof type II specification.

## Specification

model code	MVW1F-02	MVW1RF-02
Port size	Rc 1/8 · Rc 1/4 · Rc 3/8	
Effective sectional area	3.0 mm <sup>2</sup>	
Operating pressure	0 ~ 0.8MPa	
Proof pressure	1.2MPa	
Fluid temperature	- 20 ~ 50°C	
Ambient temperature	- 20 ~ 50°C (Remove moisture perfectly from the fluid to prevent freezing when used at 5°C or lower.)	
Solenoid	Rated voltage	See model code section.
	Allowable voltage fluctuation	± 10% of applicable voltage
	Temperature rise	Max. 80°C
	Insulation class	JIS C 4003 Class B
	Power consumption	AC.....10VA    DC.....6W
Response time	AC.....Less than 0.02s	DC.....Less than 0.03s
Performance frequency	Max. 4 cycle/s	Min. 1 cycle/6 mon.
Mass	0.4kg	

● For specifications other than those listed above, please contact us.



# External Dimensions

Normally Closed

MVW1F-02

Normally Open

MVW1RF-02

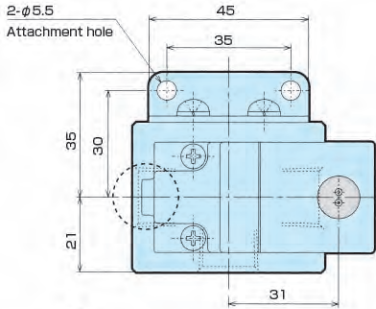

**A**

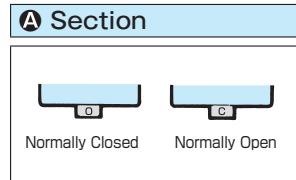
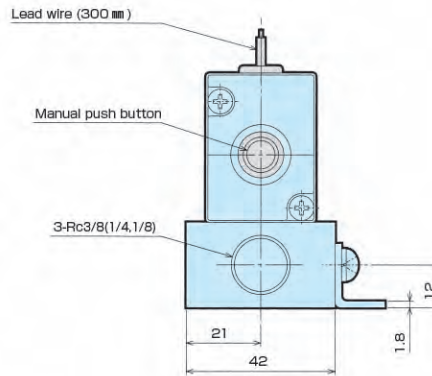
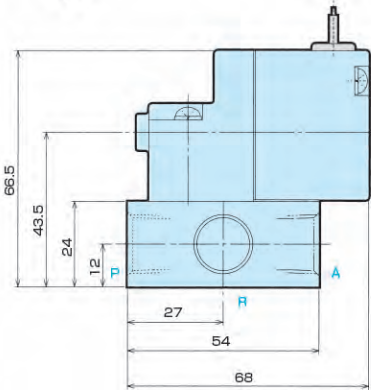

## DIN connector (Option) Installation

MVW1F(R)-02-S-□-DT  
-DN  
-DTZ  
-DNZ

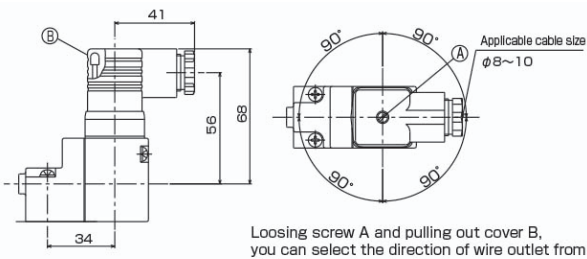

## Conduit connector (Option) Installation

MVW1F(R)-02-S-□-TB1  
-TBF1N  
-TBF1Z  
-TBF1NZ

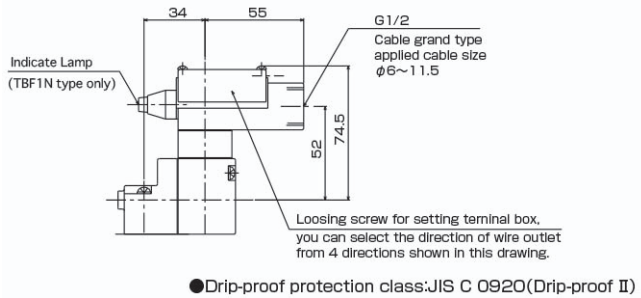

## Actuation

Normally Closed

MVW1F-02

SOL.De-energized

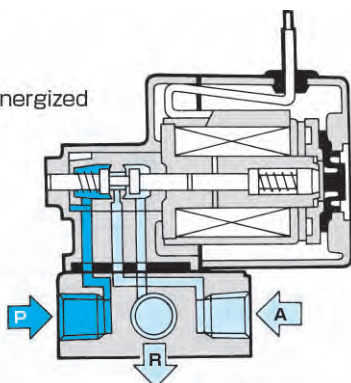

SOL.Energized

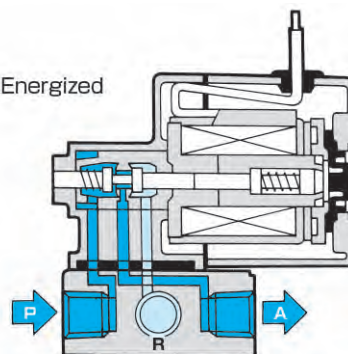

# 5

## MAGSTER II F

### Port SOLENOID VALVES

#### Gasket-connected type

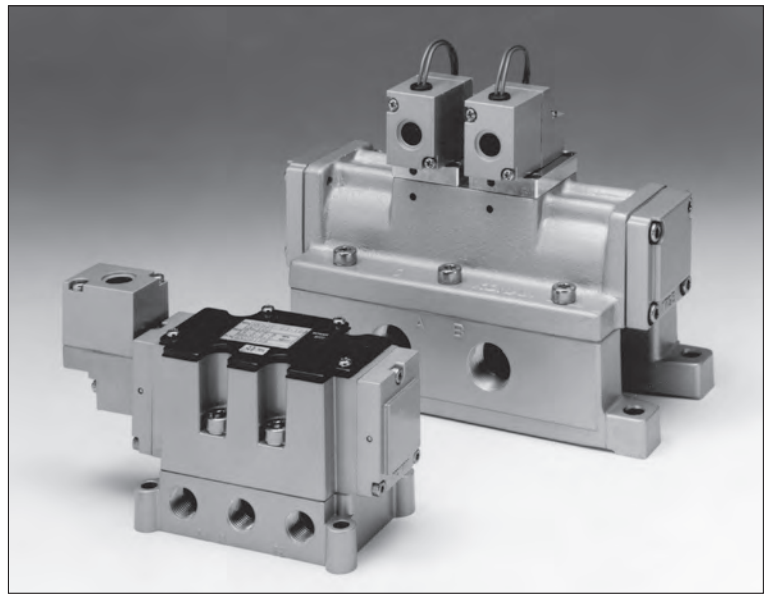

MVS2F-03 · 08	2 Positions	Return	Rc 1/4 · 3/8 · 1/2 · 3/4 · 1
MVD2F-03 · 08		Hold	
MVPCF-03 · 08	3 Positions	Closed center	
MVPOF-03 · 08		Center open to exhaust	
MVPEF-03 · 08		Center open to pressure	

**Model Code** When ordering, specify the model as follows.

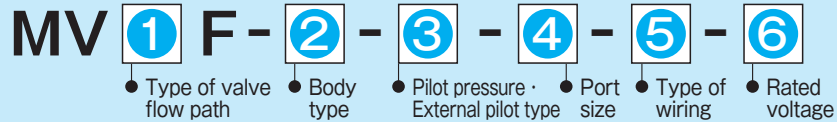

1 Type of valve flow path			
2 Position	Return		S2
	Hold		D2
3 Position	Closed center		PC
	Center open to exhaust		PO
	Center open to pressure		PE

2 Body type	
Rc 1/4	03
Rc 3/8	
Rc 1/2	08
Rc 3/4	
Rc 1	

3 Pilot pressure · External pilot type	
Internal (Standard) pilot type	No entry
External pilot type	P

4 Port size	
Rc 1/4	8A
Rc 3/8	10A
Rc 1/2	15A
Rc 3/4	20A
Rc 1	25A

5 Type of wiring		
Lead wire		No entry
With terminal box	w/o lamp	T
	with lamp	N
With terminal box · with surge absorber	w/o lamp	TZ
	with lamp	NZ
DIN connector	w/o lamp	DT
	with lamp	DN
DIN connector with surge absorber	w/o lamp	DTZ
	with lamp	DNZ

6 Rated voltage	
AC100V 50/60Hz	AC100
AC110V 50/60Hz	AC110
AC200V 50/60Hz	AC200
AC220V 50/60Hz	AC220
AC125V 50/60Hz	AC125
DC24V	DC24
DC48V	DC48
DC100V	DC100
DC110V	DC110

## ■ Specification

Model code	Return	MVS2F-03			MVS2F-08	
	Hold	MVD2F-03			MVD2F-08	
	Closed center	MVPCF-03			MVPCF-08	
	Center open to exhaust	MVPOF-03			MVPOF-08	
	Center open to pressure	MVPEF-03			MVPEF-08	
Port size	Rc 1/4	Rc 3/8	Rc 1/2	Rc 3/4	Rc 1	
Effective sectional area	40mm <sup>2</sup>	55mm <sup>2</sup>	70mm <sup>2</sup>	175mm <sup>2</sup>	185mm <sup>2</sup>	
Operating pressure	0.2 ~ 0.8MPa			0.12 ~ 0.7MPa		
	Case of external pilot type Pilot operating pressure $\geq$ Operating pressure					
Proof pressure	1.2MPa			1.05MPa		
Fluid temperature	-5 ~ 50°C	(Remove moisture perfectly from the fluid to prevent freezing when used at 5°C or lower.)		-20 ~ 50°C	(Remove moisture perfectly from the fluid to prevent freezing when used at 5°C or lower.)	
Ambient temperature	-5 ~ 50°C	(Remove moisture perfectly from the fluid to prevent freezing when used at 5°C or lower.)		-20 ~ 50°C	(Remove moisture perfectly from the fluid to prevent freezing when used at 5°C or lower.)	
Solenoid	Rated voltage	See model code section.				
	Allowable voltage fluctuation	$\pm 10\%$ of applicable voltage				
	Temperature rise	Max. 80°C (Resistance method)				
	Insulation class	JIS C 4003 Class B				
	Power consumption	AC.....10VA		DC.....6W		
Response time	AC.....Less than 0.03s	DC.....Less than 0.05s	AC.....Less than 0.07s	DC.....Less than 0.05s		
Performanse frequency	Max. 4 cycle/s		Min. 1 cycle/6 mon.			
Mass	Return.....0.4kg		Other.....1.6kg		Return.....4.5kg	Other.....5kg







2 Positions · Return MVS2F — 08

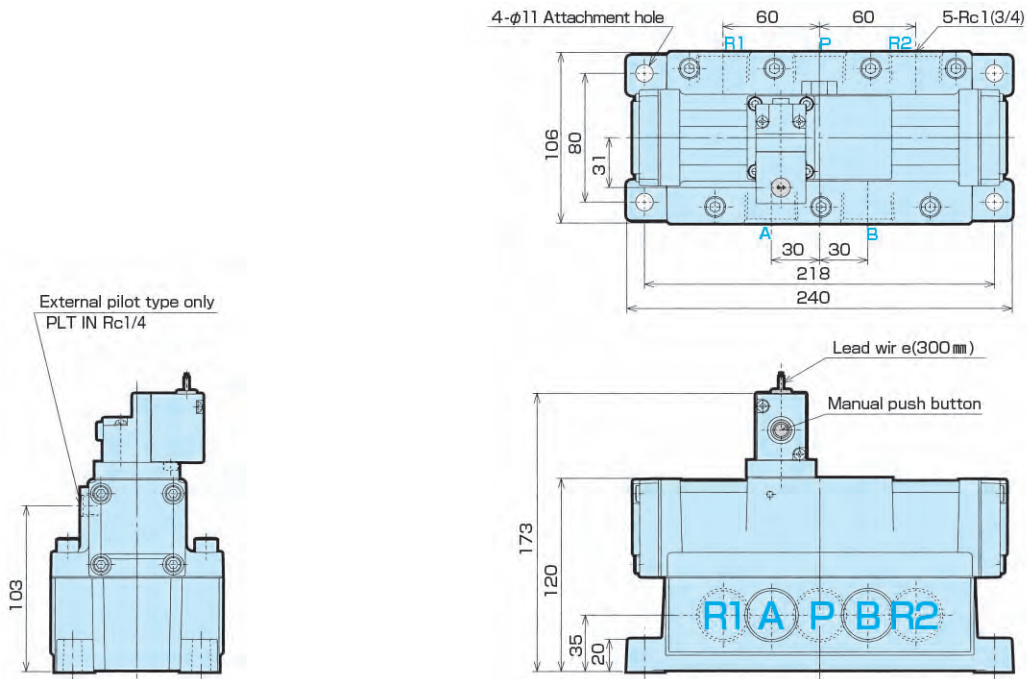

■ DIN connector (Option) Installation

MV□□F-08-□-DT  
 -DN  
 -DTZ  
 -DNZ

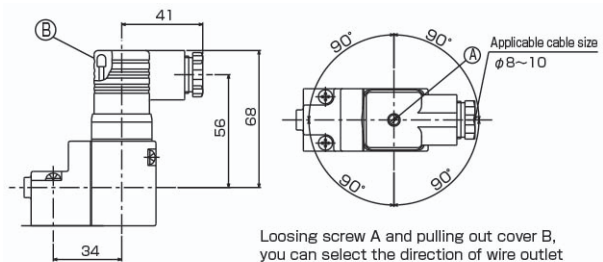

With terminal box

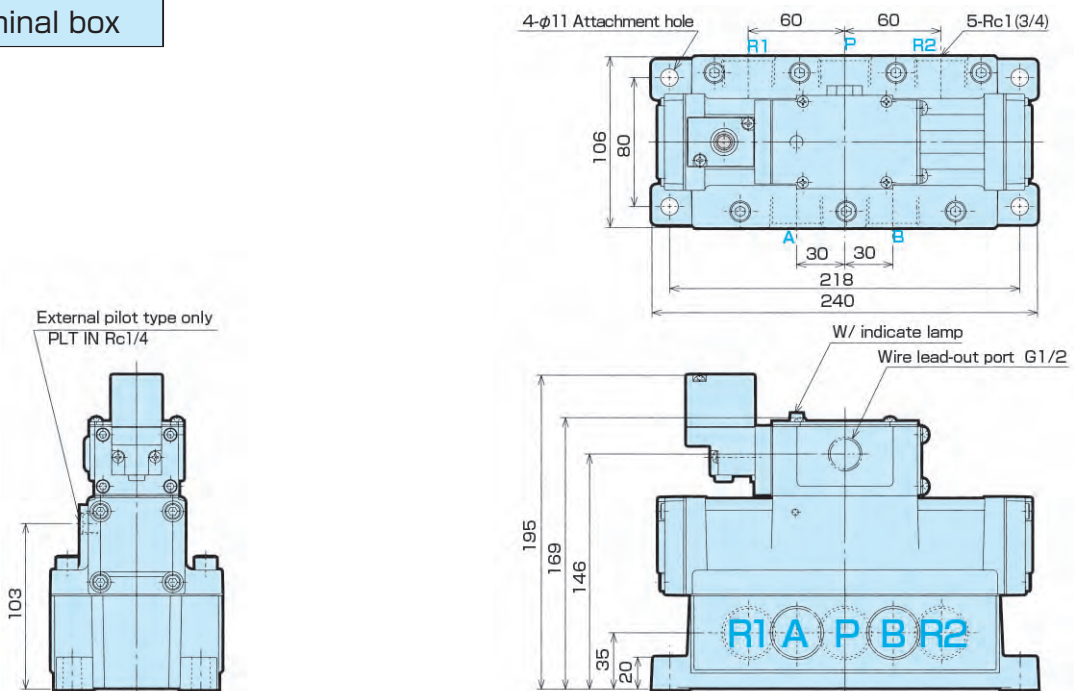



# External Dimensions

2 Positions · Hold	MVD2F — 08
3 Positions · Closed center	MVPCF — 08
3 Positions · Center open to exhaust	MVPOF — 08
3 Positions · Center open to pressure	MVPEF — 08

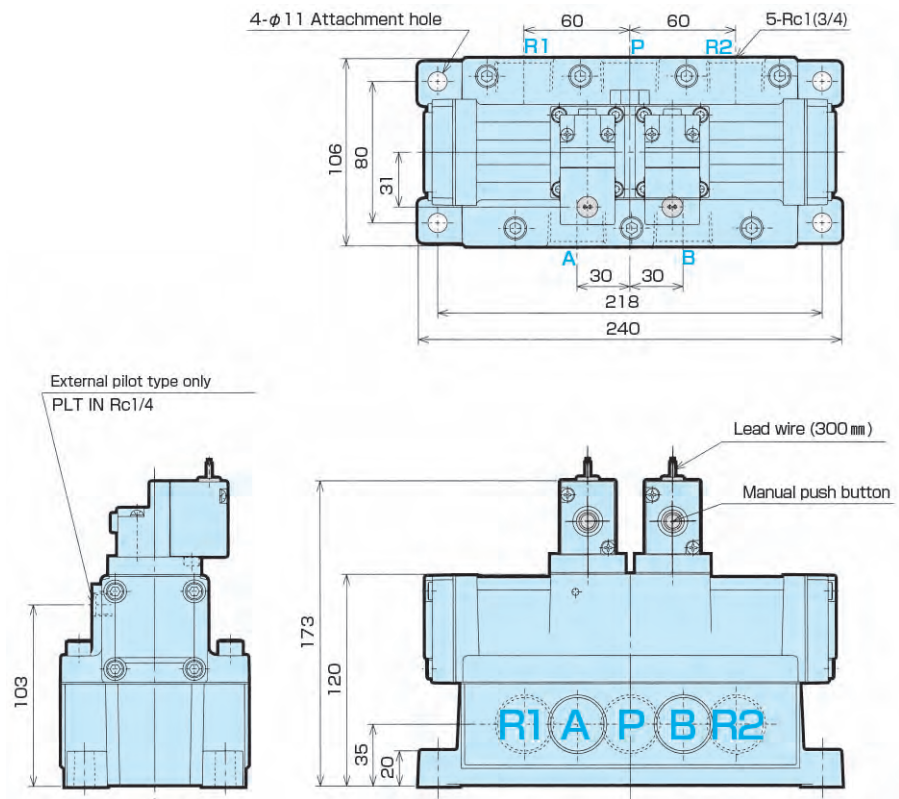

## With terminal box

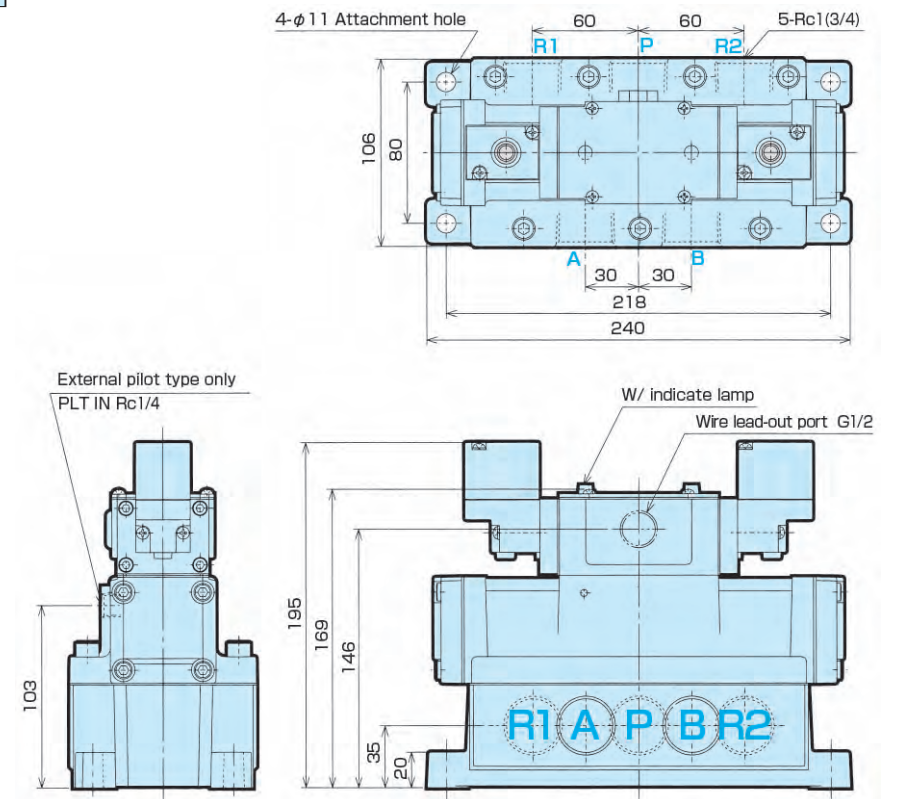

# Actuation

MVS2F-08

Return

SOL • De-energized

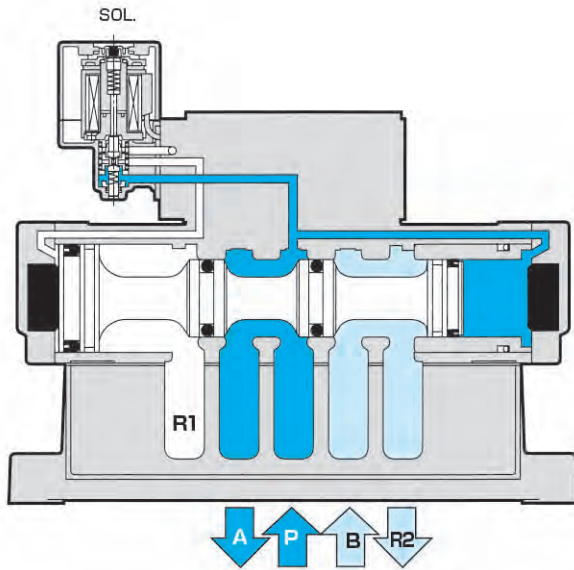

SOL • Energized

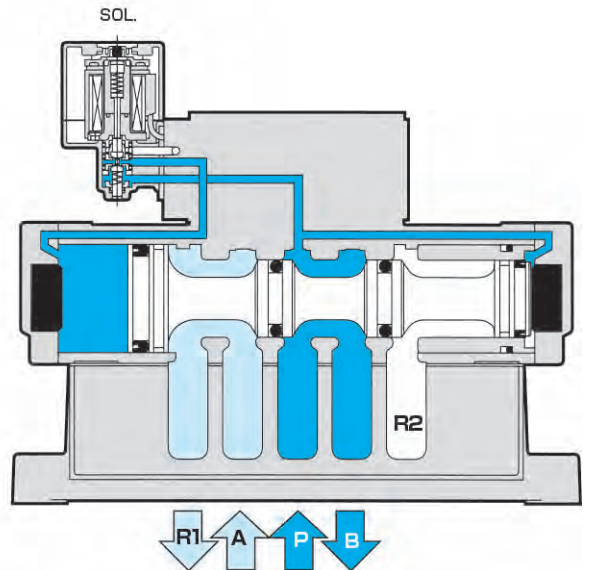

MVD2F-08

Hold

SOL • 1 Energized SOL • 2 De-energized

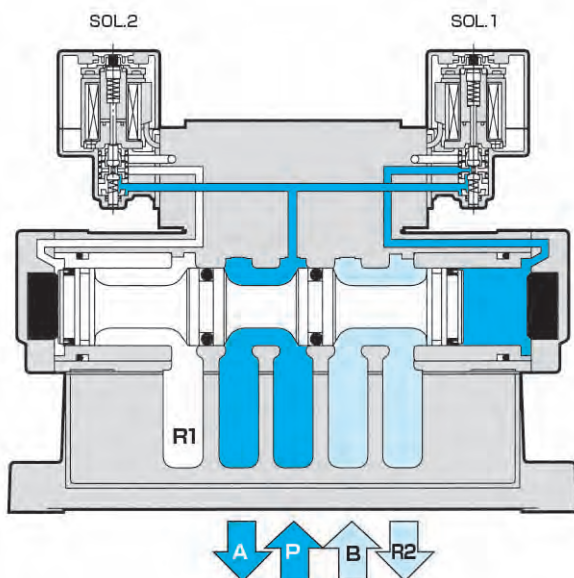

SOL • 1 De-energized SOL • 2 Energized

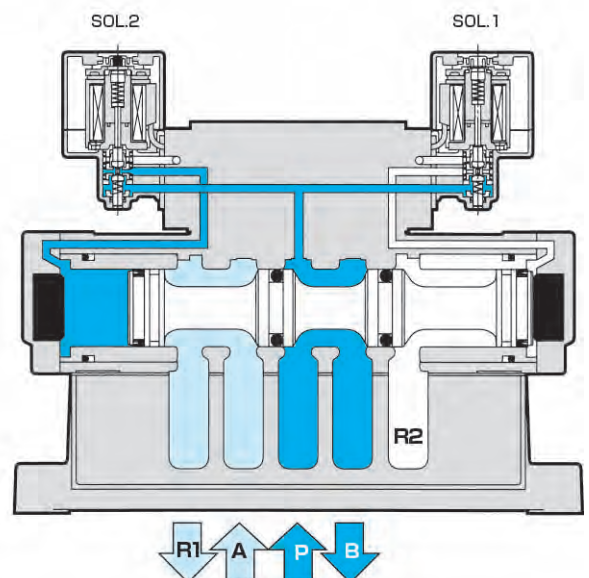

# Manifold Information

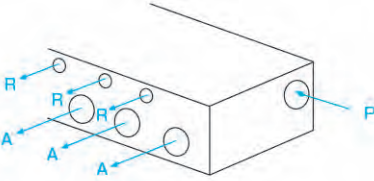
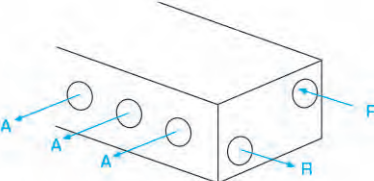
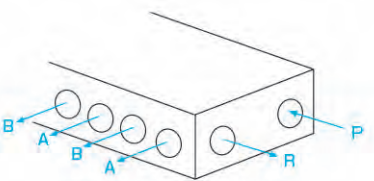
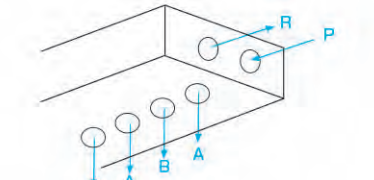
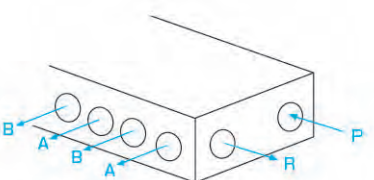
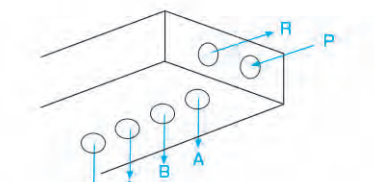
	Port size (Rc)	Basic model	Manifold base piping direction	Applicable single solenoid valve	
				Model code (Abbreviations)	
3 Port Solenoid Valves Gasket-connected type	1/8 ·	MVM3F-02-SE1	Individual exhaust port 	MVW1F-02 (W) MVW1FR-02 (R)	
	1/4 · 3/8	MVM3F-02-SP1	Collective exhaust port 		
5 Port Solenoid Valves Gasket-connected type	3/8 ·	MVM5F-03-SP1	Collective exhaust port 	MVS2F-03 (S) MVD2F-03 (D) MVPCF-03 (C) MVPOF-03 (O) MVPEF-03 (E)	
		1/2			MVM5F-03-SP2 
	3/4 · 1	MVM5F-08-SP1			
		MVM5F-08-SP2 			



	Number of valves to be connected	Standard specifications				Special note	Others
		Effective sectional area		Response time	Maximum usable frequency (at maximum number of connections)		
		Bore code	(mm <sup>2</sup> )				
	15	02-6A	3.0	AC : Less than 0.02s	4 cycle/s	An aluminum manifold base with an integrated structure that makes it easy to inspect and replace each solenoid valve. In addition, it is possible to mix and connect solenoid valves that are always closed and always open.	Other specifications are the same as the applicable single solenoid valve. Refer to each applicable section.
02-8A		DC : Less than 0.03s					
02-10A							
	6	03-10A	55	AC : Less than 0.03s	4 cycle/s	Since only the bases for the number of connected units are connected with bolts to form a manifold base, inspection and replacement of each solenoid valve can be easily performed without removing the piping. The SP1 type base has an OUT port with a side piping type, and the SP2 type base has an OUT port with a bottom piping type. In addition, single-acting, double-acting, and 3-position solenoid valves can be mixed and connected, respectively.	The effective cross-sectional area in the standard specification column in the table on the left shows the value when one solenoid valve is operated.
03-15A		70	DC : Less than 0.05s				
	4	08-20A	175	AC : Less than 0.07s	1 cycle/2s		Contact us if you are using other than the specifications shown in the table on the left.
08-25A		185	DC : Less than 0.08s				

# 3 MAGSTER II

## Port SOLENOID VALVES

### Manifold type

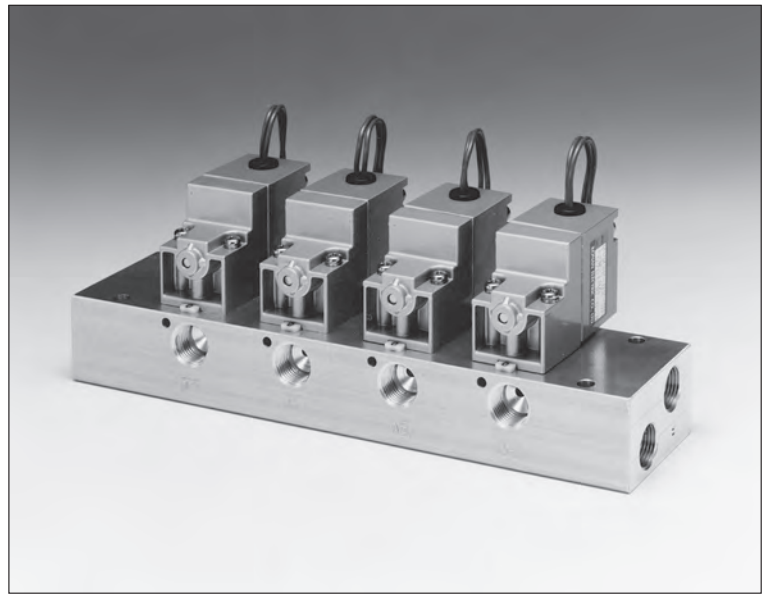

MVM3F-02-SE1	Individual exhaust	Rc 1/8 · 1/4 ·
MVM3F-02-SP1	Collective exhaust	3/8

**Model Code** When ordering, specify the model as follows.

**MVM3F-02-** 1 - 2 - 3 - 4 - 5 - 6 - 7

● Manifold base type ● Solenoid valve type ● No. of valves connected ● Port size ● Type of wiring ● Rated voltage ● Solenoid valve arrangement order

**1 Manifold base type**

Individual exhaust port		SE1
Collective exhaust port		SP1

**2 Solenoid valve type**

Solenoid valve type	Normally closed	Normally open
	MVW1F	MVW1RF
Single manifold	W	R
Complex manifold mounting	M	

**3 No. of valves connected**

No. of valves connected	Codes
2	2
3	3
4	4
⋮	⋮
14	14
15	15

**4 Port size**

Rc 1/8	6A
Rc 1/4	8A
Rc 3/8	10A

**5 Type of wiring**

Lead wire	No entry	
	DIN connector	w/o lamp
	with lamp	DN
DIN connector with surge absorber	w/o lamp	DTZ
	with lamp	DNZ
Conduit connector	w/o lamp	TBF1
	with lamp	TBF1N
Conduit connector with surge absorber	w/o lamp	TBF1Z
	with lamp	TBF1NZ

**6 Rated voltage**

AC100V 50/60Hz	AC100
AC110V 50/60Hz	AC110
AC200V 50/60Hz	AC200
AC220V 50/60Hz	AC220
AC125V 50/60Hz	AC125
DC24V	DC24
DC48V	DC48
DC100V	DC100
DC110V	DC110

● The conduit connector has a waterproof class (JIS C 0920), drip-proof type II specification.

**7 Solenoid valve arrangement order**

- No entry for a single manifold.
  - Use the abbreviation of the applicable solenoid valve to specify the arrangement number position in the JIS symbol column.
- Ex) In a 15 series manifold, if W (constantly closed) is indicated in the positions 1. 3. 5. 7. 9. 9. F. H. K., and R (constantly open) in the positions 2. 4. 6. 8. E.G.J

1 2 3 4 5 6 7 8 9 E F G H J K  
 WRWRWRWRWRWRWRWRWR  
 MVM3F-02-○-M-15-○-○-○-  
 -W13579FHKR2468EGJ

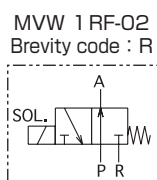
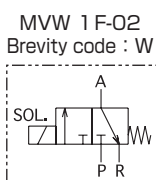

Either of the above applies to the JIS symbol sequence NO. column.

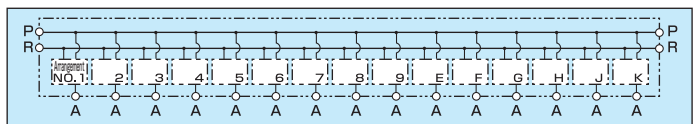
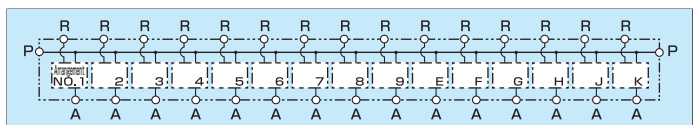

# External Dimensions

Individual exhaust port MVM3F-02-SE1

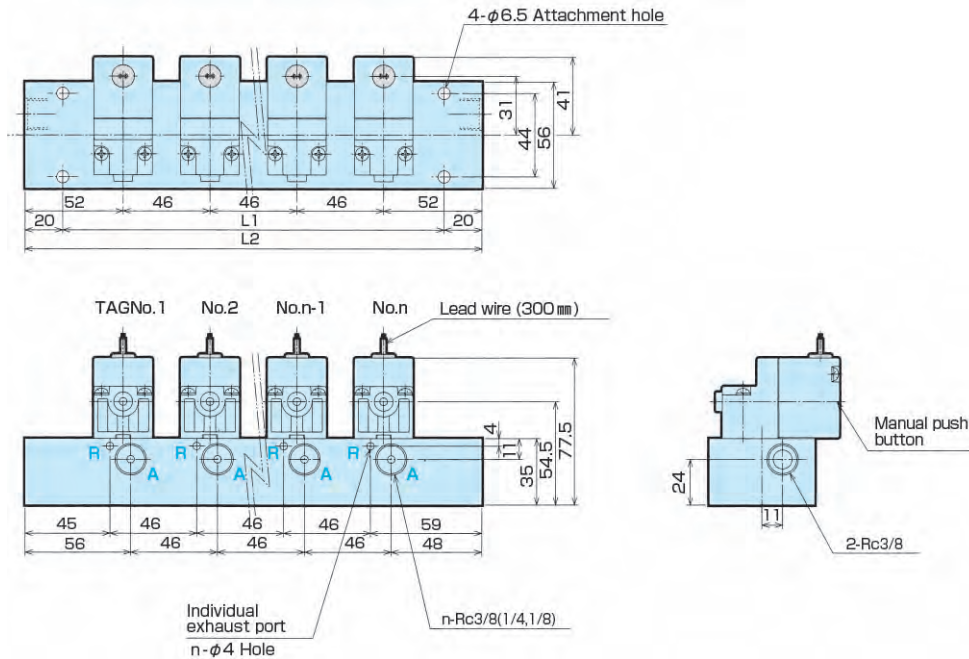

## ■ Dimensions

No. of valves connected(n)	2	3	4	5	6	7	8	9	10	11	12	13	14	15
L1(mm)	110	156	202	248	294	340	386	432	478	524	570	616	662	708
L2(mm)	150	196	242	288	334	380	426	472	518	564	610	656	702	748
Mass(kg)	1.2	1.8	2.4	3.0	3.6	4.2	4.8	5.4	6.0	6.6	7.2	7.8	8.4	9.0

Collective exhaust port MVM3F-02-SP1

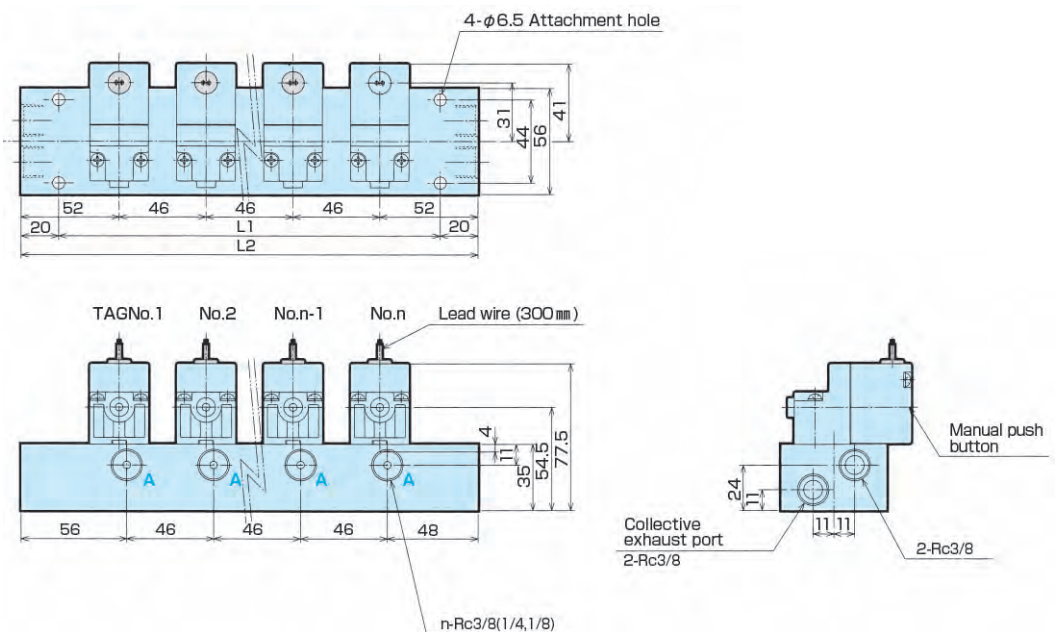

## ■ Dimensions

No. of valves connected(n)	2	3	4	5	6	7	8	9	10	11	12	13	14	15
L1(mm)	110	156	202	248	294	340	386	432	478	524	570	616	662	708
L2(mm)	150	196	242	288	334	380	426	472	518	564	610	656	702	748
Mass(kg)	1.2	1.8	2.4	3.0	3.6	4.2	4.8	5.4	6.0	6.6	7.2	7.8	8.4	9.0

# 5

## MAGSTER II F

### Port SOLENOID VALVES

#### Manifold type

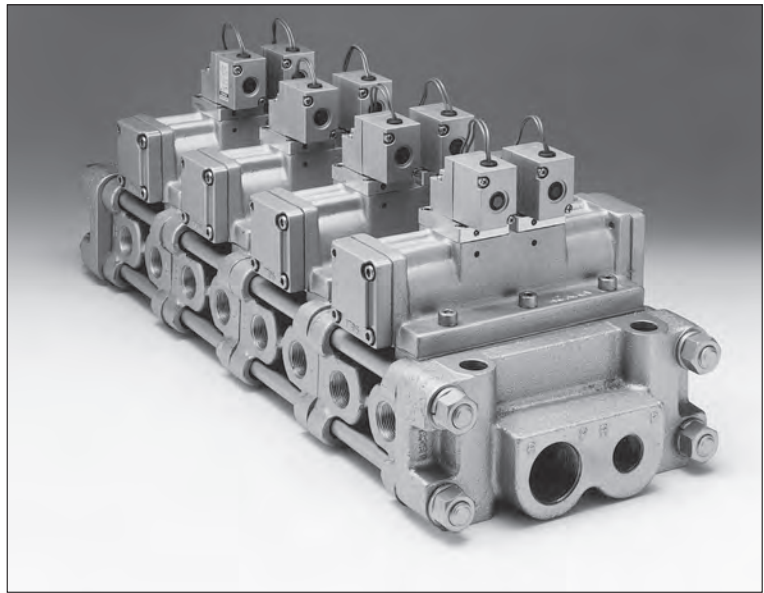

MVM5F-03 · SP1	Horizontal piping type	Rc 3/8 · 1/2 · 3/4 · 1
MVM5F-08 · SP1		
MVM5F-03 · SP2	Lower piping type	
MVM5F-08 · SP2		

**Model Code** When ordering, specify the model as follows.

**MVM5F -** 1 - 2 - 3 - 4 - 5 - 6 - 7 - 8

● Body size    ● Manifold base type    ● Solenoid valve type    ● No. of valves connected    ● Port size    ● Type of wiring    ● Rated voltage    ● Solenoid valve arrangement order

**1 Body size**

Rc 3/8	03
Rc 1/2	
Rc 3/4	08
Rc 1	

**2 Manifold base type**

Horizontal piping type (Collective exhaust port)		SP1
Lower piping type (Collective exhaust port)		SP2

**3 Solenoid valve type**

Solenoid valve type	Codes	
	Single	Compound
MVS2F-03/08	S	M
MVD2F-03/08	D	
MVPCF-03/08	C	
MVPOF-03/08	O	
MVPEF-03/08	E	

**4 No. of valves connected**

No. of valves connected	Codes
2	2
3	3
4	4
※ 5	5
※ 6	6

**5 Port size**

Rc 3/8	10A
Rc 1/2	15A
Rc 3/4	20A
Rc 1	25A

Note) **1** : If the character entered in the type of main body is 08, the maximum number of connections is 4.

**6 Type of wiring**

Lead wire		No entry
With terminal box	w/o lamp	T
	with lamp	N
With terminal box · with surge absorber	w/o lamp	TZ
	with lamp	NZ
DIN connector	w/o lamp	DT
	with lamp	DN
DIN connector with surge absorber	w/o lamp	DTZ
	with lamp	DNZ

**8 Solenoid valve arrangement order**

- No entry for a single manifold.
- Use the abbreviation of the applicable solenoid valve to specify the arrangement number position in the JIS symbol column.

Ex) In a 6 series manifold, if S (Single-acting) is indicated in the positions 1, 3., D (Double-acting) is indicated in the positions 4, 6., and O (2 Positions · Center open to exhaust) in the positions 5.

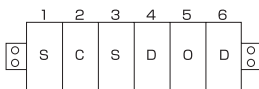

<Model>  
MVM5F-03-○-M-6-○-○-○-S13D46C2○5

section : Either of the following applies to the item

JIS symbol

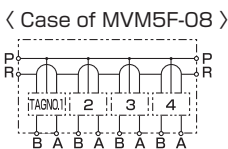
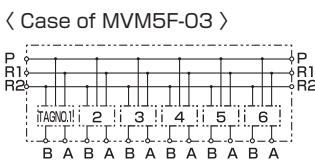

MVS2F-03/08 brevity code : S	MVD2F-03/08 brevity code : D
MVPCF-03/08 brevity code : C	MVPOF-03/08 brevity code : O
MVPEF-03/08 brevity code : E	

The total number of MVPCF, MVPOF, and MVPEF is up to three.



# External Dimensions

## Horizontal piping type MVM5F-03-SP1

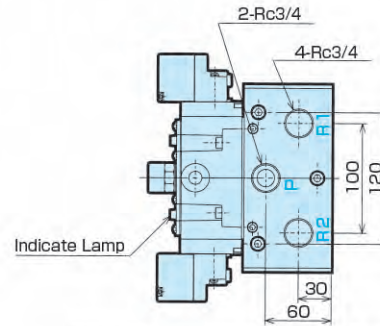
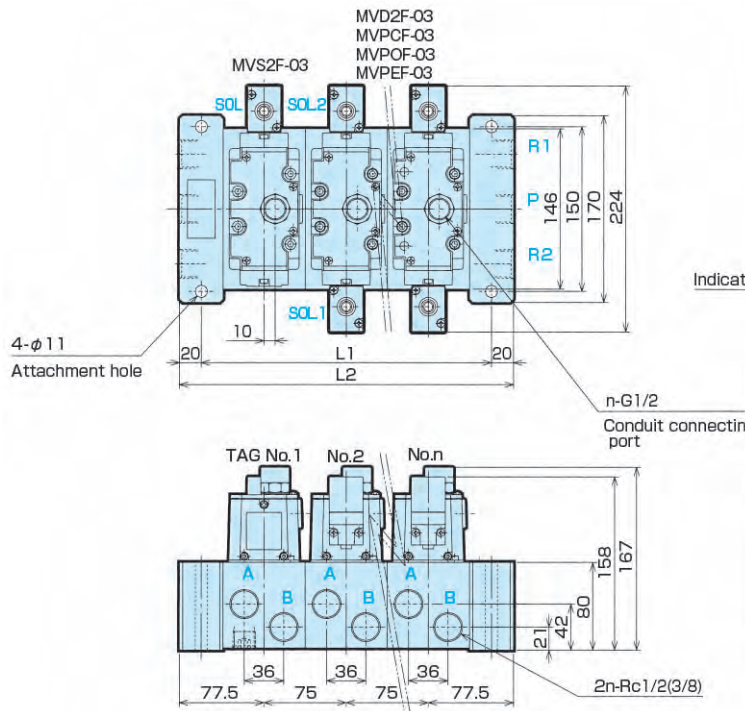

MVM5F-03-SP2 type (Lower piping type)

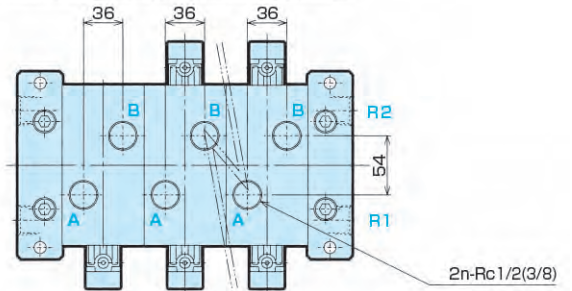

### Dimensions

No. of valves connected (n)	2	3	4	5	6
L1 (mm)	190	265	340	415	490
L2 (mm)	230	305	380	455	530
Mass (kg)	6.4	8.1	9.8	11.5	13.2

## Horizontal piping type MVM5F-08-SP1

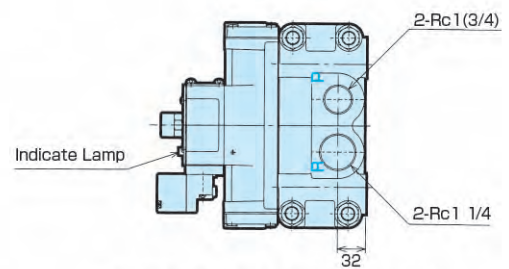
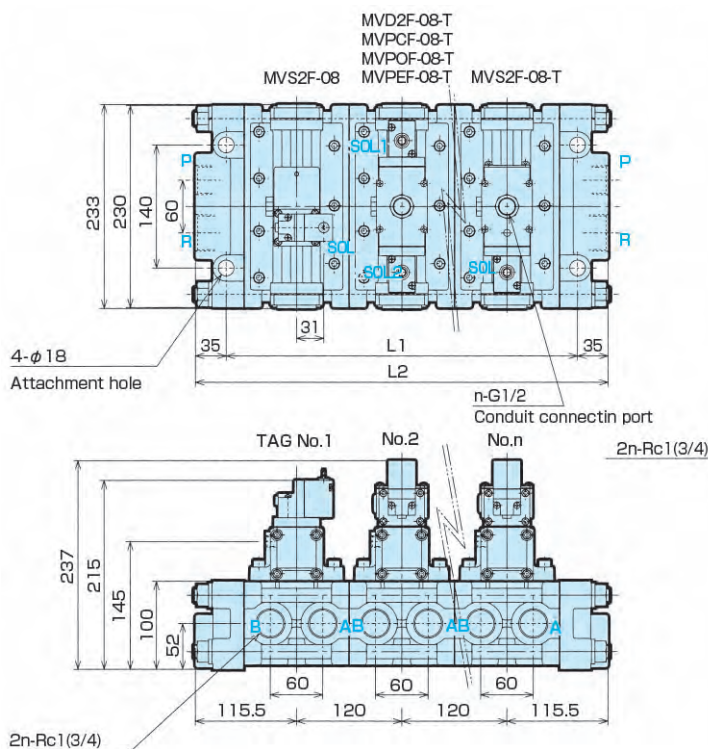

MVM5F-08-SP2 type (Lower piping type)

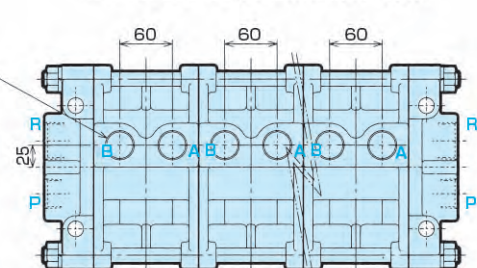

### Dimensions

No. of valves connected (n)	2	3	4
L1 (mm)	281	401	521
L2 (mm)	351	471	591
Mass (kg)	16.0	19.4	22.6

# 5

## MAGSTER II F

### Port Air Operated Valves

#### Gasket-connected type

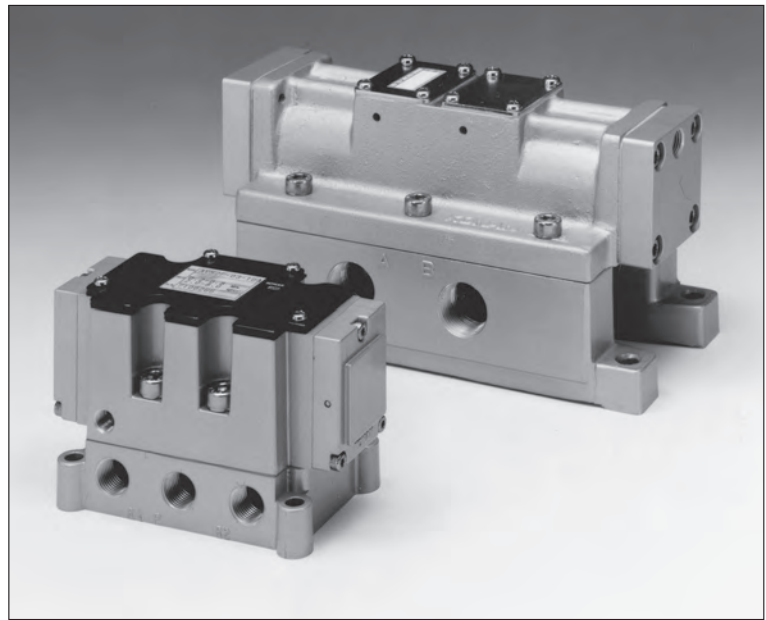

AVS2 * -03 · 08	2 Positions	Return	Rc 1/4 · 3/8 · 1/2 · 3/4 · 1
AVD2 * -03 · 08		Hold	
AVPC * -03 · 08	3 Positions	Closed center	1
AVPO * -03 · 08		Center open to exhaust	
AVPE * -03 · 08		Center open to pressure	

**Model Code** When ordering, specify the model as follows.

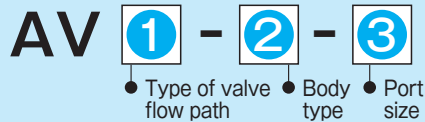

#### 1 2 Type of valve flow path and body type

	Type of valve flow path	JIS symbol	Codes	
			1 Type of valve flow path	2 Body type
2 Position	Return		S2F	03
			S2	08
	Hold		D2F	03
			D2	08
3 Position	Closed center		PCF	03
			PC1	08
	Center open to exhaust		POF	03
			PO1	08
	Center open to pressure		PEF	03
			PE1	08

#### 3 Port size

Body type	Port size	Codes
03	Rc 1/4	8A
	Rc 3/8	10A
	Rc 1/2	15A
08	Rc 3/4	20A
	Rc 1	25A

#### Note)

\*1 Refer to section 3 for details on the body type.

\*2 Exhausted PLT.1 : P→A B→R2

Exhausted PLT.2 : P→B A→R2

Pressurize both PLT.1 and PLT.2 at the intermediate position.

\*3 Pressurized PLT.1 : P→A B→R2

Pressurized PLT.2 : P→A B→R2

Both PLT.1 and PLT.2 at exhausted at the intermediate position.

## Specification

Model code	Return	AVS2F-03			AVS2-08	
	Hold	AVD2F-03			AVD2-08	
	Closed center	AVPCF-03			AVPC1-08	
	Center open to exhaust	AVPOF-03			AVPO1-08	
	Center open to pressure	AVPEF-03			AVPE1-08	
Port size		Rc 1/4	Rc 3/8	Rc 1/2	Rc 3/4	Rc 1
Effective sectional area		40mm <sup>2</sup>	55mm <sup>2</sup>	70mm <sup>2</sup>	175mm <sup>2</sup>	185mm <sup>2</sup>
Pilot operating pressure		0.2 ~ 0.8MPa (However, Pilot operating pressure ≥ Operating pressure)			0.12 ~ 0.7MPa (However, Pilot operating pressure ≥ Operating pressure)	
Operating pressure		0.2 ~ 0.8MPa			0.12 ~ 0.7MPa	
Fluid temperature		-5 ~ 50°C (Remove moisture perfectly from the fluid to prevent freezing when used at 5°C or lower.)			-20 ~ 60°C (Remove moisture perfectly from the fluid to prevent freezing when used at 5°C or lower.)	
Ambient temperature		-5 ~ 50°C			-20 ~ 60°C	
Mass		1.0kg			3.0kg	

AVD2F-03	Hold
----------	------

PLT.1 : Pressurized    PLT.2 : Exhaust

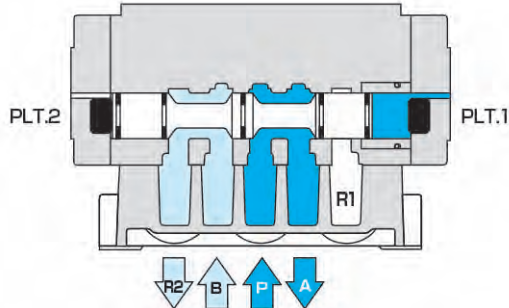

PLT.1 : Exhaust    PLT.2 : Pressurized

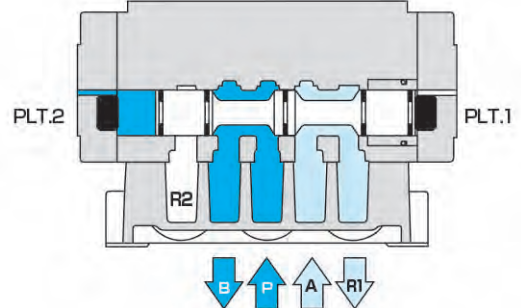

AVS2-08	Return
---------	--------

When PLT.1 is not pressurized.

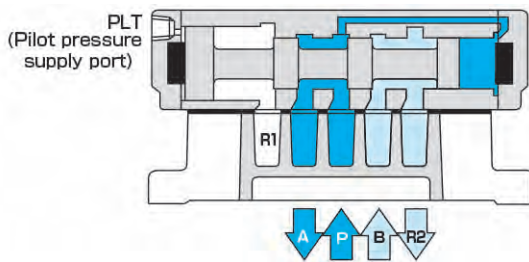

When PLT. is pressurized

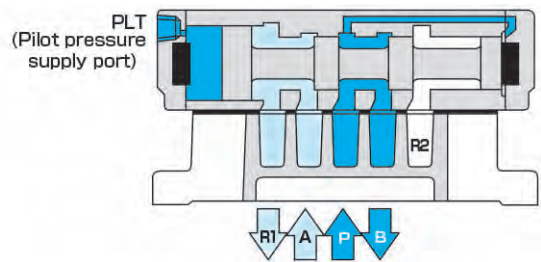

AVPC1-08	Closed center
----------	---------------

When PLT. 1 and PLT. 2 is pressurized

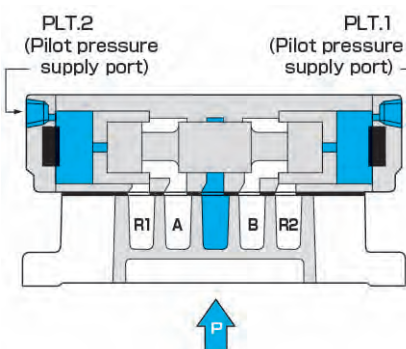

When PLT.1 is exhausted and PLT.2 is pressurized

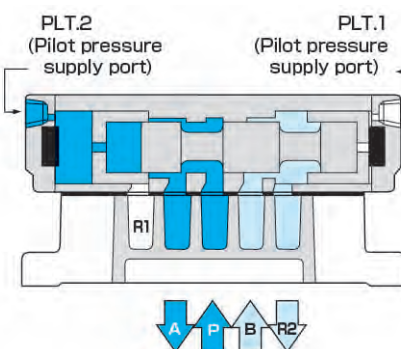

When PLT.2 is exhausted and PLT.1 is pressurized

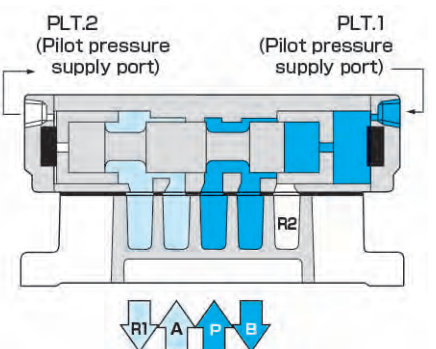



# External Dimensions

2 Positions · Return

AVS2F – 03

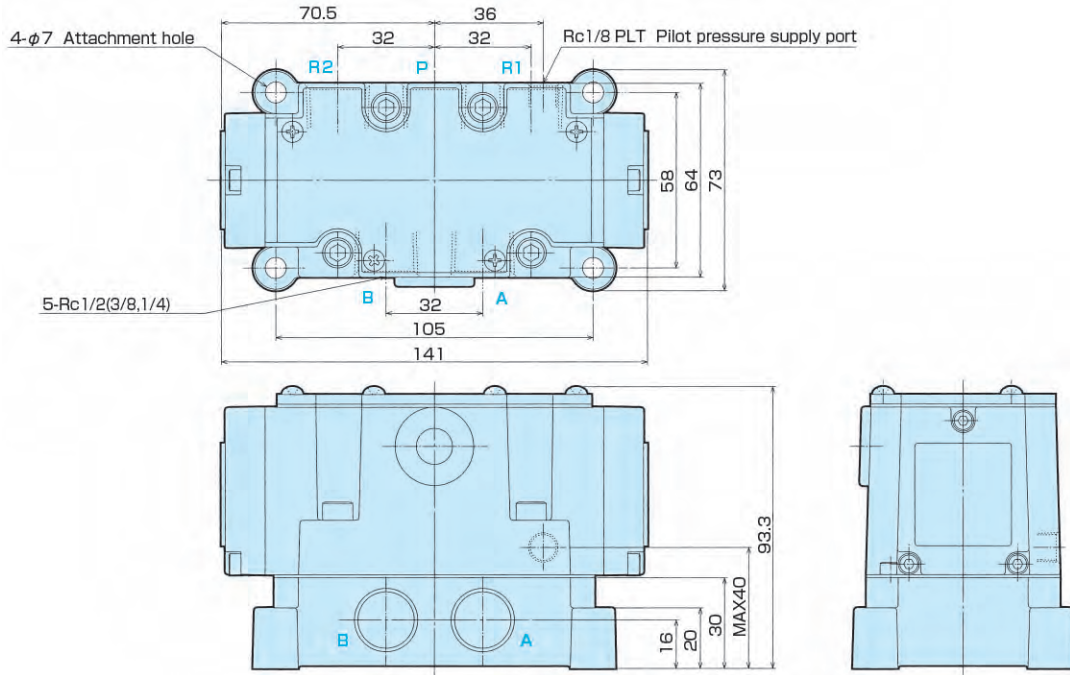

2 Positions · Hold

AVD2F – 03

3 Positions · Closed center

AVPCF – 03

3 Positions · Center open to exhaust

AVPOF – 03

3 Positions · Center open to pressure

AVPEF – 03

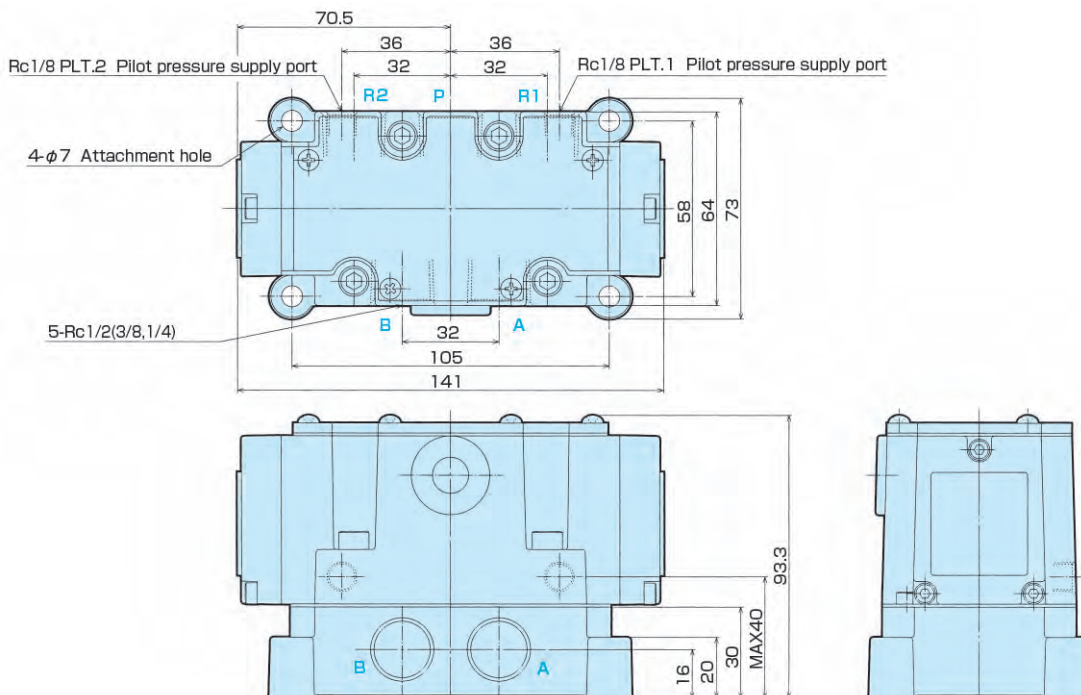



2 Positions · Return	AVS2 – 08
----------------------	-----------

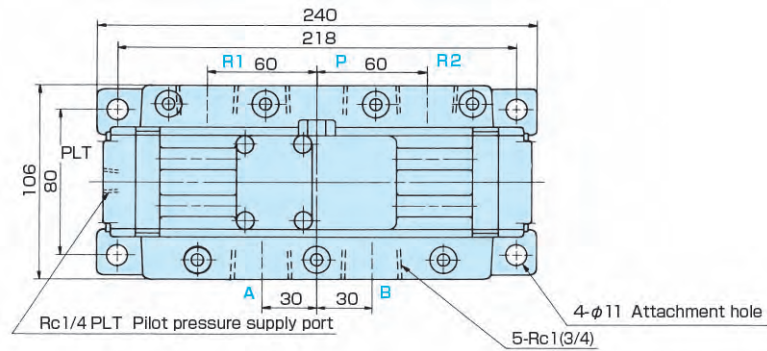

2 Positions · Hold	AVD2 – 08
3 Positions · Closed center	AVPC1 – 08
3 Positions · Center open to exhaust	AVPO1 – 08
3 Positions · Center open to pressure	AVPE1 – 08

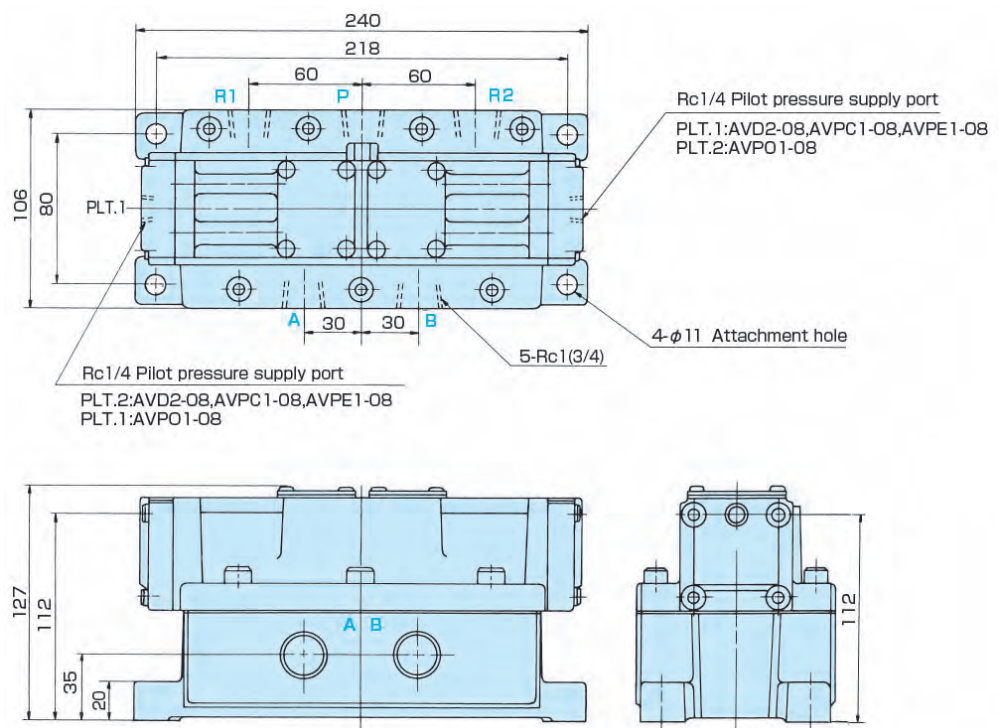

# Determination of Flow-Rat [Reference]

## ■ To Determine Flow Rate · 1

(To calculate flow rate using effective cross sectional area of valve)

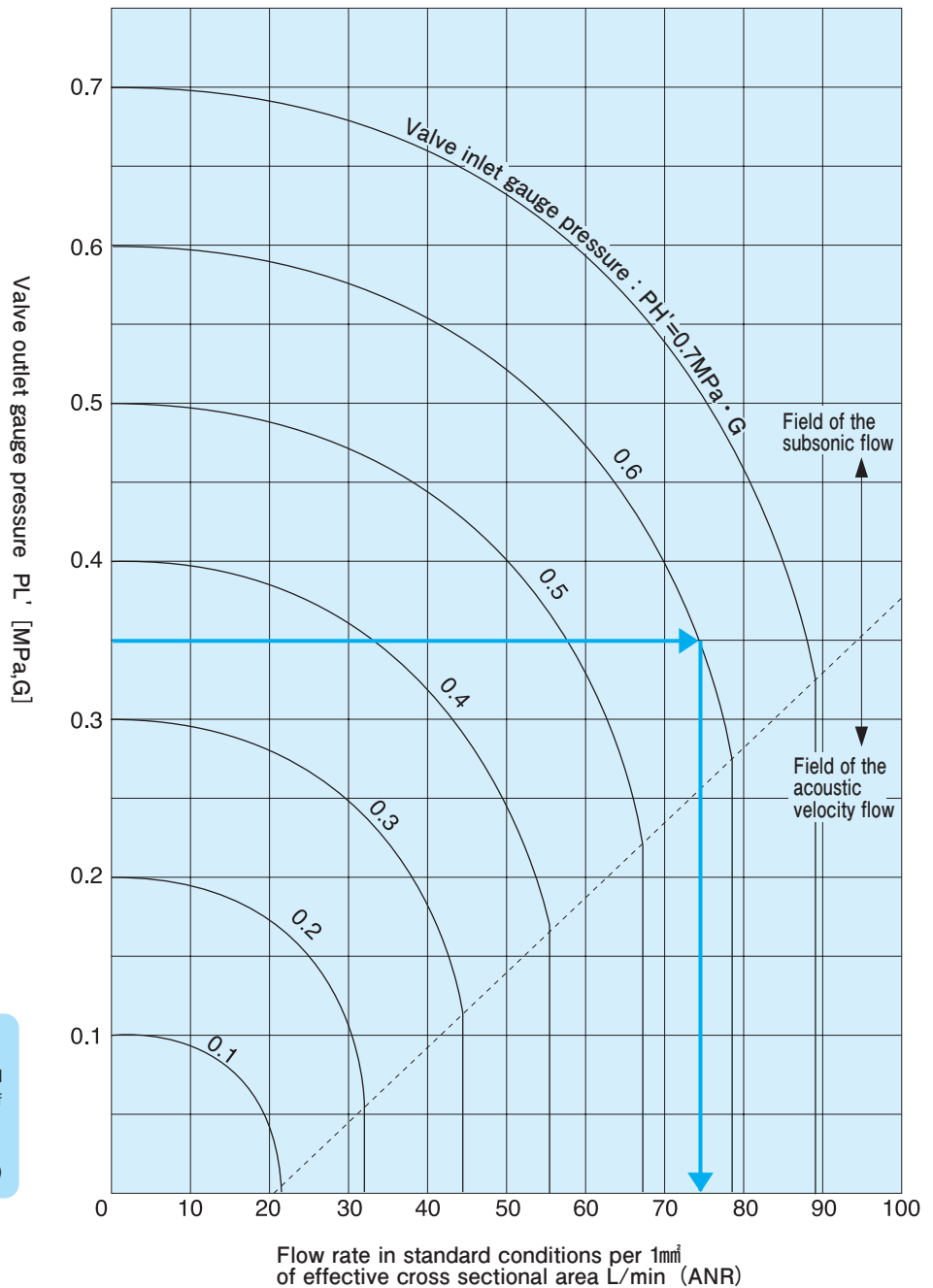

### [Eg.]

When valve inlet pressure is 0.6 MPa and outlet pressure 0.35 MPa, the flow rate of the valve with effective cross sectional area  $20 \text{ mm}^2$  is calculated as follows:  
 $75 \text{ L/min (ANR)} \times 20 \text{ mm}^2 = 1500 \text{ L/min (ANR)}$

## ◇ Flow Rate Calculation

- $P_H = (1 \sim 1.89) P_L$   
 (In the case of subsonic flow) :

$$Q = 236S \sqrt{P_L (P_H - P_L)} \cdot \sqrt{\frac{293}{T}}$$

- $P_H = > 1.89 P_L$   
 (In the case of acoustic velocity flow) :

$$Q = 118S P_H \sqrt{\frac{293}{T}}$$

Q : Flow [L/min (ANR)]  
 S : Effective sectional area [ $\text{mm}^2$ ]  
 $P_H$  : Valve inlet absolute pressure [MPa,abs] = [Gauge pressure  $P_H' + 0.101$ ] [MPa]  
 $P_L$  : Valve outlet absolute pressure [MPa,abs] = [Gauge pressure  $P_L' + 0.101$ ] [MPa]  
 T : Valve inlet absolute temperature [K]

### Note

ANR shows standard condition of the air and shows 20 degrees Celsius, pressure of air in 1 atm.

## ■ To Determine Flow Rate · 2

(To calculate effective cross sectional area of valve using flow rate)

**A**

When ratio of valve inlet absolute pressure  $P_H$  (gauge pressure  $P_H' + 0.101$ ) to valve outlet absolute pressure  $P_L$  (gauge pressure  $P_L' + 0.101$ ) ( $P_H/P_L$ ) is  $> 1.89$  (In the case of acoustic velocity flow)

[Eg.]

When valve inlet pressure is 0.5 MPa, the valve effective sectional area requiring flow rate 6,000 L/min (ANR) is 90mm<sup>2</sup>.

◆ When the flow rate is 20,000L/min (ANR) or less.

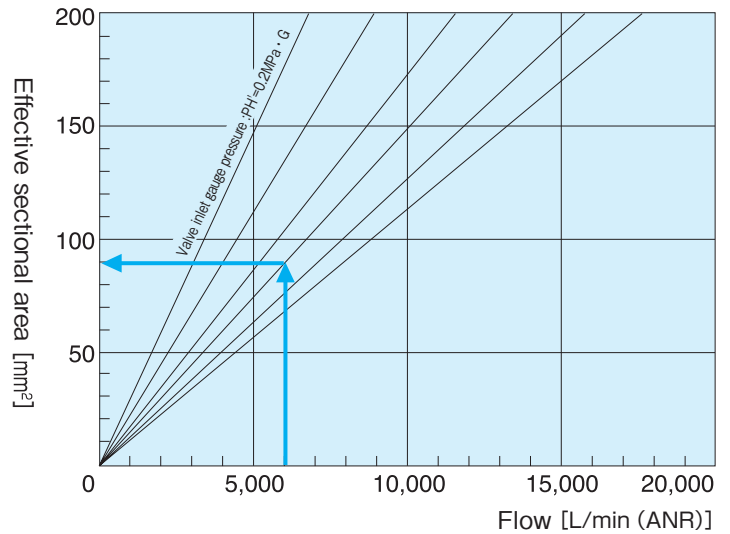

◆ When the flow rate is 200,000L/min (ANR) or less.

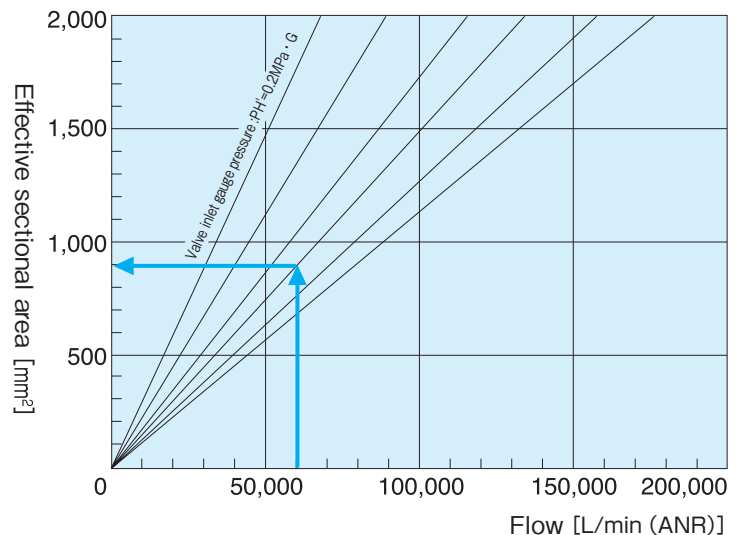

[Eg.]

When valve inlet pressure is 0.5 MPa, the valve effective sectional area requiring flow rate 60,000 L/min (ANR) is 900mm<sup>2</sup>.

**B**

When  $P_H/P_L$  is  $> 1.89$  :  
Effective cross sectional area of the valve is determined by the following formula :  
(In the case of acoustic velocity flow)

$$\text{Effective sectional area [mm}^2\text{]} = \frac{\text{Flow [L/min]}}{236 \times (\text{The coefficient that found by a lower list})}$$

$P_H' \backslash P_L'$	0.65	0.6	0.55	0.5	0.45	0.4	0.35	0.3	0.25
0.7	0.194	0.265	0.313	0.347	0.372	—	—	—	—
0.6	—	—	0.181	0.246	0.288	0.317	—	—	—
0.5	—	—	—	—	0.660	0.224	0.261	—	—
0.4	—	—	—	—	—	—	0.151	0.201	—
0.3	—	—	—	—	—	—	—	—	0.133

$P_H'$  : Inlet gauge pressure [MPa,G]      $P_L'$  : Outlet gauge pressure [MPa,G]

Eg.

Effective cross sectional area when  $P_H'=0.6$ ,  $P_L'=0.45$ , flow rate 3,000L/min (ANR) :  

$$\frac{3000}{236 \times 0.288} = 44.1\text{mm}^2$$

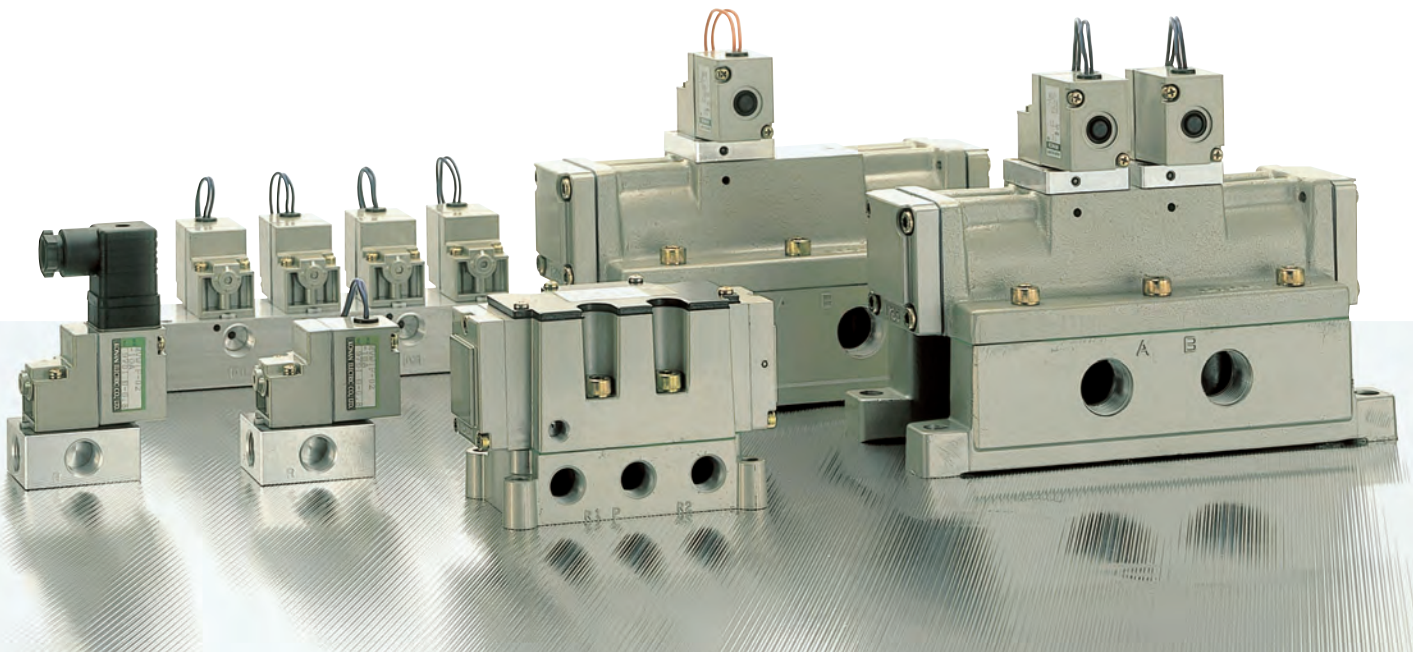

**KONAN®**

**KONAN ELECTRIC CO.,LTD.**

**Tokyo Branch**

Shiba-Wakamatsu Bldg.7-8, Shiba 4-chome, Minatoku, Tokyo 108-0014, Japan  
Phone: +81-3-3454-1711 Fax: +81-3-3454-8699

**Osaka Branch**

Hankyu Terminal Bldg.1-4, Shibata 1-chome, Kitaku, Osaka 530-0012, Japan  
Phone: +81-6-6373-6701 Fax: +81-6-6373-6740

**Seibu Branch**

Momiji Hiroshima Hikarimachi Bldg.12-20, Hikarimachi, 1-chome, Higashiku, Hiroshima, 732-0052, Japan  
Phone: +81-82-568-0071 Fax: +81-82-568-0072

**International Operation Division**

4-97, Uedahigashimachi, Nishinomiya, Hyogo, 663-8133, Japan  
Phone: +81-798-48-5931 Fax: +81-798-40-6659



Tohoku Office	Phone: +81-22-215-1195
Chiba Office	Phone: +81-43-305-1401
Hokkaido Office	Phone: +81-11-792-7451
Nagoya Office	Phone: +81-52-581-6541
Kanazawa Office	Phone: +81-76-233-1411
Takamatsu Office	Phone: +81-87-835-0411
Hiroshima Office	Phone: +81-82-568-0071
Kitakyushu Office	Phone: +81-93-541-0281

**Distributing Agent**

2020.12  
Please note that this catalog is subject to revision without notice.

2021.07-1版(D3)-K

URL=<https://www.konan-em.com/>